

About this Manual

We've added this manual to the Agilent website in an effort to help you support your product. This manual is the best copy we could find; it may be incomplete or contain dated information. If we find a more recent copy in the future, we will add it to the Agilent website.

Support for Your Product

Agilent no longer sells or supports this product. Our service centers may be able to perform calibration if no repair parts are needed, but no other support from Agilent is available. You will find any other available product information on the Agilent Test & Measurement website, www.tm.agilent.com.

HP References in this Manual

This manual may contain references to HP or Hewlett-Packard. Please note that Hewlett-Packard's former test and measurement, semiconductor products and chemical analysis businesses are now part of Agilent Technologies. We have made no changes to this manual copy. In other documentation, to reduce potential confusion, the only change to product numbers and names has been in the company name prefix: where a product number/name was HP XXXX the current name/number is now Agilent XXXX. For example, model number HP8648A is now model number Agilent 8648A.

POWER METER 435A

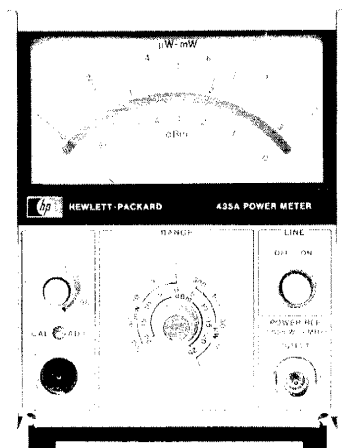

HEWLETT  PACKARD



OPERATING AND SERVICE MANUAL

POWER METER 435A

**(Including Options 001, 002, 003,
009, 010, 011, 012, and 013)**

SERIAL NUMBERS

This manual applies directly to instruments with serial numbers prefixed 1312A.

With changes described in Section VII, this manual also applies to instruments with serial numbers prefixed 1234A.

For additional important information about serial numbers, see INSTRUMENTS COVERED BY MANUAL in Section I.

Copyright HEWLETT-PACKARD COMPANY 1973
1501 PAGE MILL ROAD, PALO ALTO, CALIFORNIA, U.S.A.

MANUAL PART NO. 00435-90011

Microfiche Part No. 00435-90012

Operating Information Supplement Part No. 00435-90006

Overall Schematic Part No. 00435-90007

Printed: JULY 1974

CONTENTS

Section	Page	Section	Page
I. GENERAL INFORMATION	1-1	4-3. Equipment Required	4-1
1-1. Introduction	1-1	4-5. Test Record	4-1
1-7. Instruments Covered by Manual	1-1	4-7. Performance Tests	4-1
1-13. Description	1-1	4-10. Power Reference Output Test	4-1
1-16. Options	1-2	4-11. Zero Carryover Test	4-2
1-17. Battery	1-2	4-12. Instrumentation Accuracy Test Without Calibrator	4-3
1-20. Input-Output Options	1-2	4-13. Instrumentation Accuracy Test With Calibrator	4-5
1-23. Cable Options	1-2		
1-25. Accessories Supplied	1-3	V ADJUSTMENTS	5-1
1-27. Equipment Required But Not Supplied	1-3	5-1. Introduction	5-1
1-29. Equipment Available	1-3	5-5. Safety Considerations	5-1
1-32. Recommended Test Equipment	1-3	5-11. Equipment Required	5-1
1-34. Safety Considerations	1-3	5-13. Factory Selected Components	5-1
		5-15. Adjustment Locations	5-1
II INSTALLATION	2-1	5-17. Power Meter Adjustments with 50Ω Power Sensor	5-2
2-1. Introduction	2-1	5-18. Power Meter Adjustments with Calibrator	5-4
2-3. Initial Inspection	2-1		
2-5. Preparation for Use	2-1	VI REPLACEABLE PARTS	6-1
2-6. Meter Zeroing	2-1	6-1. Introduction	6-1
2-8. Power Requirements	2-1	6-3. Abbreviations	6-1
2-10. Line Voltage Selection	2-1	6-5. Replaceable Parts List	6-1
2-12. Power Cable	2-1	6-7. Ordering Instructions	6-1
2-14. Interconnections	2-1	6-10. Parts Provisioning	6-1
2-17. Operating Environment	2-2		
2-19. Bench Operation	2-2	VII MANUAL CHANGES	7-1
2-21. Rack Mounting	2-3	7-1. Introduction	7-1
2-25. Battery Operation	2-3	7-3. Manual Changes	7-1
2-29. Storage and Shipment	2-3	7-6. Manual Change Instructions	7-1
2-30. Environment	2-3	7-7. Modification of A4 Assembly (Serial Prefix 1234A)	7-3
2-32. Packaging	2-4		
		VIII SERVICE	8-1
III OPERATION	3-1	8-1. Introduction	8-1
3-1. Introduction	3-1	8-4. Safety Considerations	8-1
3-3. Panel Features	3-1	8-10. Service Sheets	8-1
3-5. Operator's Checks	3-1	8-14. Principles of Operation	8-1
3-7. Operating Instructions	3-1	8-16. Troubleshooting	8-1
3-9. Power Measurement Accuracy	3-1	8-21. Recommended Test Equipment	8-3
3-11. Sources of Error and Measurement Uncertainty	3-1	8-23. Repair	8-3
3-17. Corrections for Error	3-2	8-26. General Service Information	8-3
3-22. Calculating Total Uncertainty	3-2	8-27. Etched Circuit Boards	8-3
3-28. Operator's Maintenance	3-2	8-29. Component Replacement	8-3
3-31. Fuses	3-3	8-31. Operational Amplifiers	8-3
3-33. Lamp Replacement	3-3		
3-35. Battery Replacement	3-3		
IV PERFORMANCE TESTS	4-1		
4-1. Introduction	4-1		

ILLUSTRATIONS

Figure	Page	Figure	Page
1-1. HP Model 435A and Accessories Supplied	1-0	7-3. P/O A3 Assembly Schematic (Part of Change A)	7-3
1-2. Voltage Divider Network	1-4	8-1. A4 Assembly Extended for Service	8-2
2-1. Line Voltage Selection	2-2	8-2. Operational Amplifier Equivalent Circuit	8-5
2-2. Power Cable HP Part Numbers Versus Mains Plugs Available	2-2	8-3. Schematic Diagram Notes	8-6
2-3. 435A With Battery Installed	2-3	8-4. Troubleshooting Block Diagram	8-9
3-1. Line Switch Lamp Replacement	3-3	8-5. P/O A2 Range Switch Assembly (Attenuator) Component Locations	8-11
3-2. Front Panel Controls, Connectors, and Indicators	3-4	8-6. P/O A4 Assembly (DC Ampl/Sync Detector) Component and Test Point Locations	8-11
3-3. Rear Panel Controls, Connectors, and Indicators	3-5	8-7. P/O A4 Assembly (AC Ampl/Sync Detector) Schematic Diagram	8-11
3-4. Operator's Checks	3-6	8-8. A2 RANGE Switch Assembly (Low Pass Filters) Component Locations	8-12
3-5. Operating Instructions	3-7	8-9. A1 Cal Factor Switch Assembly Component Locations	8-13
3-6. Calculating Measurement Uncertainties	3-9	8-10. P/O A4 Assembly (DC Ampl/Auto Zero) Component and Test Point Locations	8-13
3-7. The Effect of Power Sensor Mismatch on Measurement Accuracy	3-11	8-11. P/O A4 Assembly (DC Ampl/Auto Zero) Schematic Diagram	8-13
3-8. Calculating Measurement Uncertainty (Uncertainty in dB Known)	3-12	8-12. A3 Power Reference Assembly Component and Test Point Locations	8-15
4-1. Zero Carryover Test Setup	4-2	8-13. A3 Power Reference Assembly, Schematic Diagram	8-15
4-2. Instrumentation Accuracy Test Setup Without Calibrator	4-3	8-14. P/O A4 Assembly (Power Supply) Compo- nent and Test Point Locations	8-17
4-3. Instrumentation Accuracy Test Setup With Calibrator	4-5	8-15. P/O A4 Assembly (Power Supply) Schematic Diagram	8-17
5-1. Power Meter Adjustment Setup Without Calibrator	5-3	8-16. Assembly, Chassis and Adjustable Components, and Test Point Locations	8-19
5-2. 435A Adjustment Setup With Calibrator	5-4		
6-1. Cabinet Parts, Exploded View	6-8		
7-1. P/O A4 Assembly Schematic (Part of Change A)	7-2		
7-2. P/O A4 Assembly Schematic (Part of Change A)	7-2		

TABLES

Table	Page	Table	Page
1-1. Specifications	1-2	6-3. Code List of Manufacturers	6-10
1-2. Recommended Test Equipment	1-4	7-1. Manual Changes by Serial Number	7-1
4-1. Performance Test Record	4-6	8-1. Etched Circuit Soldering Equipment	8-4
5-1. Factory Selected Components	5-2	8-2. Assembly, and Chassis and Adjustable Component Locations	8-19
6-1. Reference Designations and Abbreviations	6-2		
6-2. Replaceable Parts	6-4		

WARNINGS**SAFETY**

If this instrument is to be energized via an auto-transformer for voltage reduction, make sure the common terminal is connected to the earthed pole of the power source.

BEFORE SWITCHING ON THIS INSTRUMENT, the protective earth terminals of this instrument must be connected to the protective conductor of the (mains) power cord. The mains plug shall only be inserted in a socket outlet provided with a protective earth contact. The protective action must not be negated by the use of an extension cord (power cable) without a protective conductor (grounding).

Make sure that only fuses with the required rated current and of the specified type (normal blow, time delay, etc) are used for replacement. The use of repaired fuses and the short-circuiting of fuse holders must be avoided.

Whenever it is likely that the protection offered by fuses has been impaired, the instrument must be made inoperative and be secured against any unintended operation.

GROUNDING

Any interruption of the protective (grounding) conductor (inside or outside the instrument) or disconnecting the protective earth terminal is likely to make this instrument dangerous. Intentional interruption is prohibited.

HIGH VOLTAGE

Any adjustment, maintenance, and repair of the opened instrument under voltage should be avoided as much as possible and, when inevitable, should be carried out only by a skilled person who is aware of the hazard involved.

Capacitors inside the instrument may still be charged even if the instrument has been disconnected from its source of supply.

Adjustments and service described herein are performed with power supplied to the instrument while protective covers are removed. Energy available at many points may, if contacted, result in personal injury.

CAUTIONS**LINE VOLTAGE SELECTION**

BEFORE SWITCHING ON THIS INSTRUMENT, make sure the instrument is set to the voltage of the power source.

GROUNDING

BEFORE SWITCHING ON THIS INSTRUMENT, ensure that all devices connected to this instrument are connected to the protective (earth) ground.

BEFORE SWITCHING ON THIS INSTRUMENT, ensure that the line power (mains) plug is connected to a three-conductor line power outlet that has a protective (earth) ground. (Grounding one conductor of a two-conductor outlet is not sufficient.)

POWER SENSOR INPUT

See Operating Precautions in Power Sensor Operating and Service Manuals for maximum power levels which may be safely coupled to this system. Levels which exceed the limits may damage the Power Sensor, Power Meter, or both.

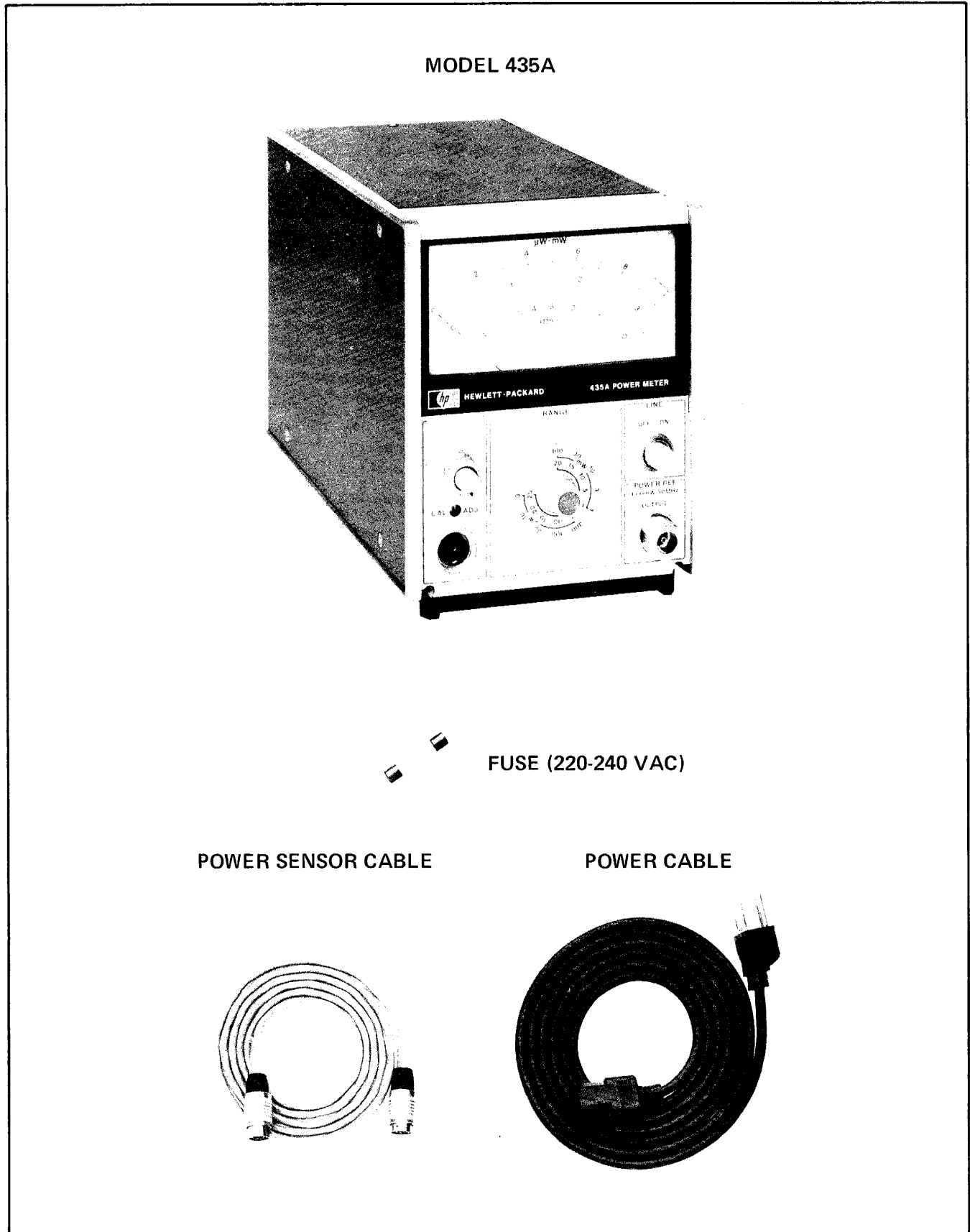

Figure 1-1. HP Model 435A and Accessories Supplied

SECTION I

GENERAL INFORMATION

1-1. INTRODUCTION

1-2. This manual provides information pertaining to the installation, operation, testing, adjustment and maintenance of the HP Model 435A Power Meter.

1-3. Figure 1-1 shows the 435A with accessories supplied.

1-4. Packaged with this manual is an Operating Information Supplement. This is simply a copy of the first three sections of this manual. This supplement should be kept with the instrument for use by the operator. Also included with the manual is an overall schematic diagram. Additional copies of both the Operating Information Supplement and the Overall Schematic Diagram may be ordered separately through your nearest Hewlett-Packard office. The part numbers are listed on the title page of this manual.

1-5. On the title page of this manual, below the manual part number, is a "Microfiche" part number. This number may be used to order 4x6-inch microfilm transparencies of the manual. The microfiche package also includes the latest Manual Changes supplement as well as all pertinent Service Notes.

1-6. Instrument specifications are listed in Table 1-1. These specifications are the performance standards or limits against which the instrument may be tested.

1-7. INSTRUMENTS COVERED BY MANUAL

1-8. Options 001, 002, 003, 009, 010, 011, 012, and 013 of the 435A are documented in this manual. The differences are noted in the appropriate location such as OPTIONS in Section I, the Replaceable Parts List, and the schematic diagrams.

1-9. This instrument has a two-part serial number. The first four digits and the letter comprise the serial number prefix. The last five digits form the sequential suffix that is unique to each instrument. The contents of this manual apply directly to instruments having the same serial number prefix(es) as listed under SERIAL NUMBERS on the title page.

1-10. An instrument manufactured after the printing of this manual may have a serial prefix that is not listed on the title page. This unlisted serial prefix indicates that the instrument is different from those documented in this manual. The manual for this instrument is supplied with a yellow Manual Changes supplement that contains change information that documents the differences.

1-11. In addition to change information, the supplement may contain information for correcting errors in the manual. To keep this manual as current and accurate as possible, Hewlett-Packard recommends that you periodically request the latest Manual Changes supplement. The supplement for this manual is keyed to the manual's print date and part number, both of which appear on the title page. Complimentary copies of the supplement are available from Hewlett-Packard.

1-12. For information concerning a serial number prefix not listed on the title page or in the Manual Changes supplement, contact your nearest Hewlett-Packard office.

1-13. DESCRIPTION

1-14. The Power Meter and a compatible Power Sensor are interconnected with the Power Sensor Cable to form a power measurement system. The system power level range, frequency response, and load impedance are dependent on the Power Sensor.

1-15. Accuracy of the power measurement system is ensured by the following Power Meter characteristics:

a. An internal automatic zeroing circuit which removes error due to the ambient temperature output of the Power Sensor's power sensing device.

b. A calibration factor adjustment which accounts for error due to the frequency response of the power sensing device.

c. An internal calibration reference which has an output of $1 \text{ mW} \pm 0.7\%$ (50Ω).

Table 1-1. Specifications

SPECIFICATIONS	
<p>System Accuracy: Instrumentation Uncertainty: $\pm 1\%$ of full scale on all ranges (0 to 55 degrees C). Zero Carryover: $\pm 0.5\%$ of full scale when zeroed on the most sensitive range.</p> <p>Reference Oscillator Accuracy: $\pm 0.70\%$ (1 mW at 50 MHz, traceable to National Bureau of Standards).</p> <p>Power Range: 55 dB with 10 full-scale ranges of 3, 10, 30, 100, and 300 μW; 1, 3, 10, 30, and 100 mW; also calibrated in dB from -25 dBm to $+20$ dBm full scale in 5 dB steps.</p> <p>Reference Oscillator: Internal oscillator with Type N female connector on front panel or rear panel (Option 003 only). Power output 1.00 mW $\pm 0.70\%$ at 50 MHz. Stability: $\pm 0.02\%/^{\circ}\text{C}$ to 55°C.</p> <p>Noise and Drift: Typically 1.5% of full-scale peak on 3 μW range, less on higher ranges (at constant temperature).</p> <p>Response Time: 2 seconds on 3 μW range, 0.75 second on 10 μW range, 0.40 second on 30 μW range,</p>	<p>and 100 milliseconds on all other ranges. (Typical, time constant measured at recorder output).</p> <p>Cal Factor: 16-position switch normalizes meter reading to account for Calibration Factor or Effective Efficiency. Range is 100% to 85% in 1% steps. 100% position corresponds to Calibration Factor at 50 MHz.</p> <p>Cal Adj: Front panel adjustment provides capability to adjust gain of meter to match power sensor in use.</p> <p>Recorder Output: Proportional to indicated power with 1 volt corresponding to full scale; 1 kΩ output impedance, BNC connector.</p> <p>RF Blanking Output: Provides a contact closure to ground when auto-zero mode is engaged.</p> <p>Power: 100, 120, 220, or 240 Vac $+5\%$, -10%, 48 to 440 Hz, less than 10 VA.</p> <p>Weight: Net, 5 lb, 12 oz (2,6 kg).</p>

1-16. OPTIONS

1-17. Battery

1-18. The Model 435A, Option 001 Power Meter is supplied with a rechargeable battery that provides up to 16 hours continuous operation from a full charge.

1-19. If the 435A was purchased without the battery option, it may be ordered in kit form under HP part number 00435-60012. The kit includes the battery, the battery clamp, a 6-32 x 1/2-inch pan head machine screw and installation instructions.

1-20. Input-Output Options

1-21. Option 002. A rear panel input connector is connected in parallel with the front panel input connector.

1-22. Option 003. A rear panel input connector replaces the standard front panel input connector; a rear panel POWER REF OUTPUT connector replaces the standard front panel connector.

1-23. Cable Options

1-24. A 5-foot Power Sensor cable is normally supplied. The 5-foot cable is omitted with any cable option. The option and cable length are shown in the table.

Option	Cable Length (feet)
009	10
010	20
011	50
012	100
013	200

1-25. ACCESSORIES SUPPLIED

1-26. The accessories supplied with the 435A are shown in Figure 1-1.

a. The 5-foot Power Sensor Cable, HP 00435-60011, is used to couple the Power Sensor to the 435A. The 5-foot cable is omitted with any cable option.

b. The line power cable may be supplied in one of four configurations. Refer to the paragraph entitled Power Cables in Section II.

c. A fuse with 1/8A rating for 220/240 Vac (HP 2110-0027) is supplied. It may replace the factory installed 1/4A fuse (HP 2110-0004) for 100/120 Vac. Refer to Line Voltage Selection in Section II.

1-27. EQUIPMENT REQUIRED BUT NOT SUPPLIED

1-28. To form a complete RF power measurement system, a Power Sensor such as the HP Model 8481A must be connected to the Power Meter via the Power Sensor Cable.

1-29. EQUIPMENT AVAILABLE

1-30. The HP Model 11683A Range Calibrator is recommended for performance testing, adjusting, and troubleshooting the 435A. The Power Meter's

range-to-range accuracy and auto-zero operation can easily be verified with the Calibrator. It also has the capability of supplying a full-scale test signal for each range.

1-31. An extender board (HP part number 5060-0683) may be used to place the A4 assembly printed circuit board in a position that allows easy access to test points and components.

1-32. RECOMMENDED TEST EQUIPMENT

1-33. The test equipment shown in Table 1-2 is recommended for use during performance testing, adjustments, and troubleshooting. To ensure optimum performance of the 435A, the specifications of a substitute instrument must equal or exceed the critical specifications shown in the table.

1-34. SAFETY CONSIDERATIONS

1-35. The 435A is a Safety Class I instrument. This instrument has been designed according to international safety standards and has been supplied in safe condition.

1-36. This operating and service manual contains information, cautions, and warnings which must be followed by the user to ensure safe operation and to retain the instrument in safe condition.

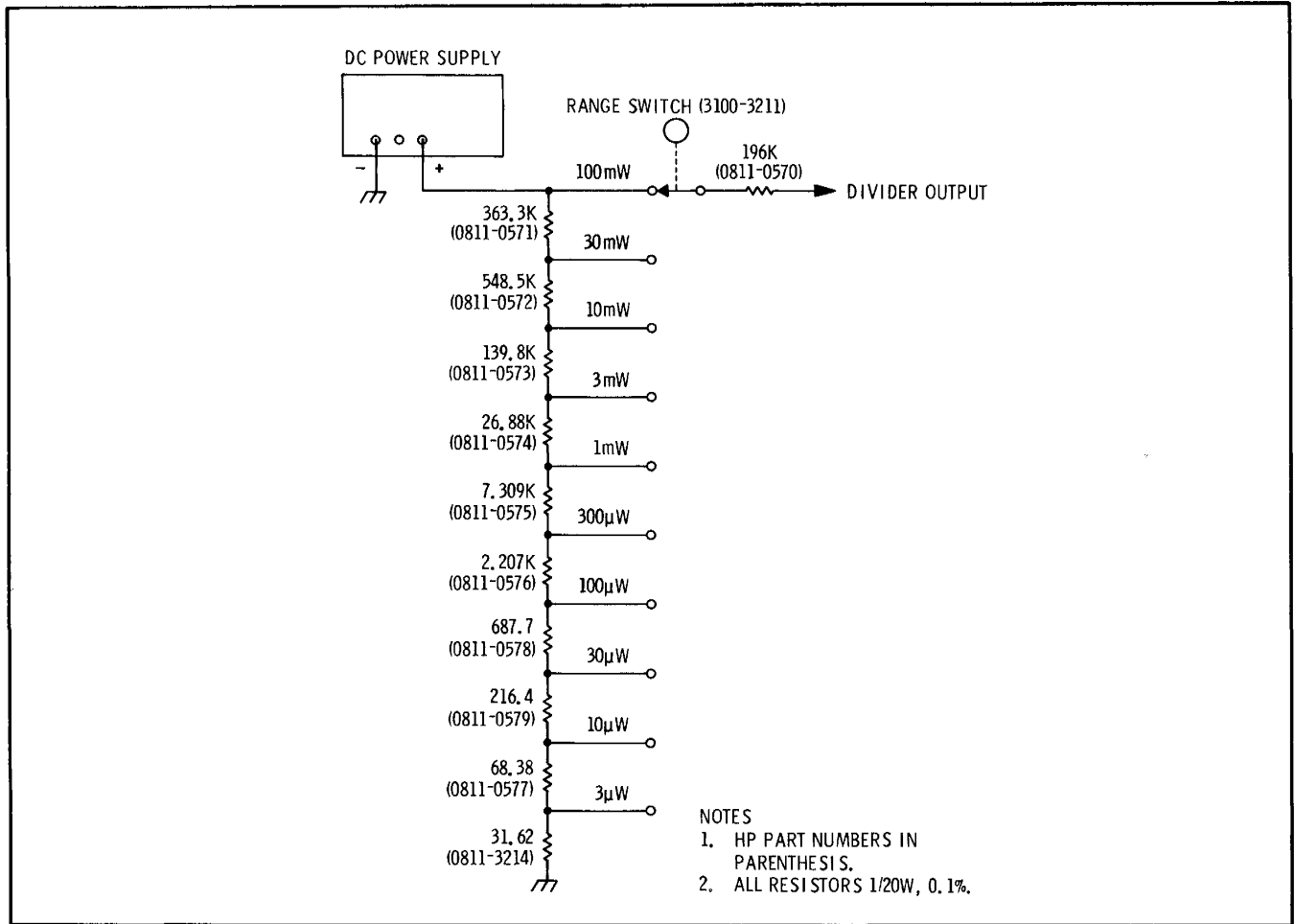

Figure 1-2. Voltage Divider Network

Table 1-2. Recommended Test Equipment

Instrument Type	Critical Specifications	Suggested Model	Use*
Digital Voltmeter	Ranges 100 mVdc , 1000 mVdc 10 M ohm input impedance 4-digit resolution $\pm(0.05\%$ of reading $\pm 0.02\%$ of range).	HP 3480A/ 3482A	P, A, T
Oscilloscope	Bandwidth dc to 50 MHz Vertical sensitivity 0.2 V/division Horizontal sensitivity 1 ms/division	HP 180A/ 1801A/1821A	P, A, T
Range Calibrator		HP 11683A	
Voltage Divider Network	$\pm 0.1\%$ resistors	See Figure 1-2	P
DC Power Supply	Voltage Range 0 to 20 Vdc Load regulation $\pm 0.01\% + 4$ mV	HP 6204A	P

* P = Performance Tests; A - Adjustments; T = Troubleshooting.

SECTION II INSTALLATION

2-1. INTRODUCTION

2-2. This section includes information on the initial inspection, preparation for use, and storage and shipment instructions of the HP Model 435A.

2-3. INITIAL INSPECTION

2-4. Inspect the shipping container for damage. If the shipping container or cushioning material is damaged, it should be kept until the contents of the shipment have been checked for completeness and the instrument has been checked mechanically and electrically. The contents of the shipment should be as shown in Figure 1-1. Procedures for checking electrical performance are given in Section IV. If the contents are incomplete, if there is mechanical damage or defect, or if the instrument does not pass the electrical performance test, notify the nearest Hewlett-Packard office. If the shipping container is damaged, or the cushioning material shows signs of stress, notify the carrier as well as the Hewlett-Packard office. Keep the shipping materials for the carrier's inspection. The HP office will arrange for repair or replacement without waiting for claim settlement.

2-5. PREPARATION FOR USE

2-6. Meter Zeroing

2-7. With the LINE switch set to OFF, the meter pointer should be positioned directly over zero. If necessary, insert a screwdriver into the mechanical Meter Zero control (beneath the meter) and align the pointer with zero. Back the adjustment off slightly. The backlash in the control ensures against a meter indication error caused by jarring the instrument.

2-8. Power Requirements

2-9. The 435A requires a power source of 100, 120, 220, or 240 Vac, +5% -10%, 48 to 440 Hz single phase. Power consumption is less than 10 VA.

WARNING

If this instrument is to be energized via an autotransformer for voltage reduction, make sure the common terminal is connected to the earthed pole of the power source.

2-10. Line Voltage Selection

CAUTION

BEFORE SWITCHING ON THIS INSTRUMENT, make sure the instrument is set to the voltage of the power source.

2-11. Figure 2-1 provides instructions for line voltage and fuse selection. The line voltage selection card and the proper fuse are factory installed for 120 Vac operation.

2-12. Power Cable

2-13. In accordance with international safety standards, this instrument is equipped with a three-wire power cable. When connected to an appropriate ac power receptacle, this cable grounds the instrument cabinet. The type of power cable plug shipped with each instrument depends on the country of destination. Refer to Figure 2-2 for the part numbers of the power cable plugs available.

WARNING

BEFORE SWITCHING ON THIS INSTRUMENT, the protective earth terminals of this instrument must be connected to the protective conductor of the (mains) power cord. The mains plug shall only be inserted in a socket outlet provided with a protective earth contact. The protective action must not be negated by the use of an extension cord (power cable) without a protective conductor (grounding).

2-14. Interconnections

2-15. The Power Meter and a Power Sensor are integral parts of this measurement system. Before measurements can be performed the Power Meter and Sensor must be connected together with the Power Sensor Cable. (The cable is supplied with the Power Meter.)

2-16. The power sensor cable couples the dc supply and sampling gate drive from the 435A to

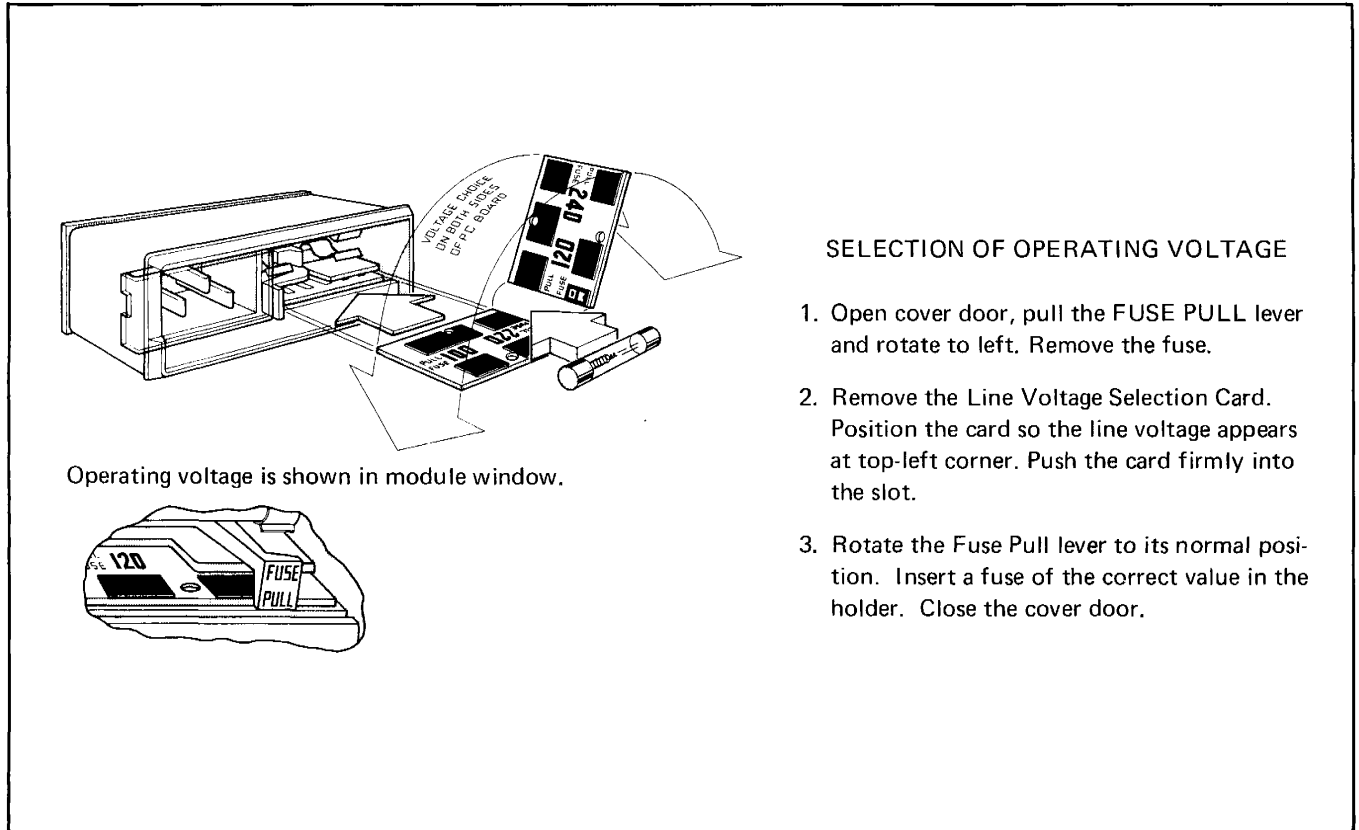

Figure 2-1. Line Voltage Selection

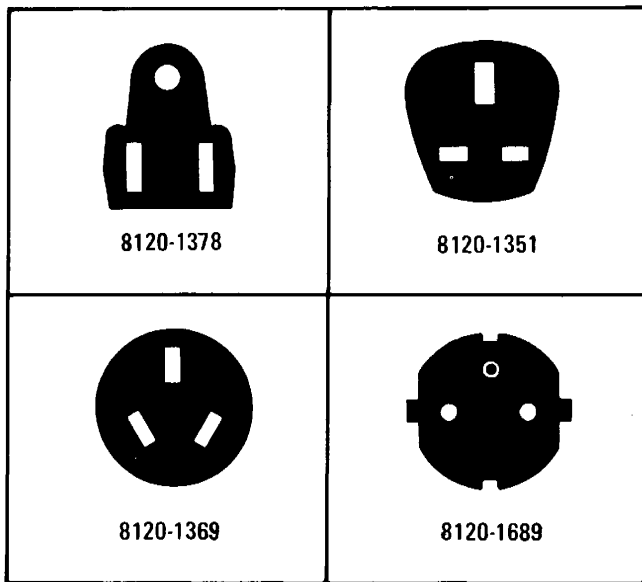

Figure 2-2. Power Cable HP Part Numbers Versus Mains Plugs Available

the Power Sensor and the 220 Hz ac output signal from the Power Sensor to the 435A.

CAUTION

The maximum voltage which may be safely coupled to the Power Meter input from the Power Sensor is 18 mVrms.

2-17. Operating Environment

2-18. The operating environment should be within the following limitations:

- Temperature 0 to 55°C
- Humidity <95% relative
- Altitude <15,000 feet

2-19. Bench Operation

2-20. The instrument cabinet has plastic feet and a fold-away tilt stand for convenience in bench

operation. (The plastic feet are shaped to ensure self-aligning of the instruments when stacked.) The tilt stand raises the front of the instrument for easier viewing of the control panel.

2-21. Rack Mounting

2-22. Instruments that are narrower than full rack-width may be rack-mounted using Hewlett-Packard adapter frames or combining cases.

2-23. Adaptor Frames. Hewlett-Packard accessory adaptor frames are an economical means of rack mounting instruments that are narrower than full rack-width. A set of spacer clamps, supplied with each adaptor frame, permits instruments of different dimensions to be combined and rack mounted as a unit. Accessory blank panels are available for filling unused spaces.

2-24. Combining Cases. Model 1051A and 1052A Combining Cases are metal enclosures that allow combinations of one-third and one-half rack-width instruments to be assembled for use on a work-bench or for mounting in a rack of standard 19-inch spacing. Each case includes a set of partitions for positioning and retaining instruments and a rack mounting kit. No tools are required for installing the partitions. For bench use the cases have the same convenient features as full rack-width instruments, (i.e., fold-away tilt stands and specially designed feet for easier instrument stacking). Accessories available for the combining cases include blank filler panels and snap-on full width control panel covers.

2-25. Battery Operation

2-26. To operate the 435A on battery power, the battery must be installed and charged, the line power cable must be disconnected, and the LINE switch must be ON.

2-27. Battery Installation. The battery is installed in the 435A as follows:

a. Hold the battery above the 435A, just behind and parallel to the printed circuit board. (The battery terminal lugs must face the circuit board.)

b. Loosen the lugs. Move the battery down into place and guide the lugs into the slots on the circuit board. The battery should now rest on the aluminum deck.

c. Place the battery clamp over the battery and secure it. The two prongs fit into slots on the rear panel and the 6-32 by 1/2-inch pan head machine screw holds the forward end of the clamp in place.

d. The battery terminal lugs should be tightened by hand.

Figure 2-3 shows the 435A with battery installed.

2-28. Battery Charging. The battery is being charged if the battery has been installed, the line power cable is connected to the available line power, and the LINE switch is ON. In the fully charged condition, (24-hour charge time), the battery will supply power for a minimum of 16 hours.

2-29. STORAGE AND SHIPMENT

2-30. Environment

2-31. The instrument should be stored in a clean, dry environment. The following environmental limitations apply to both storage and shipment:

- Temperature -40 to +75°C
- Humidity <95% relative
- Altitude <25,000 feet

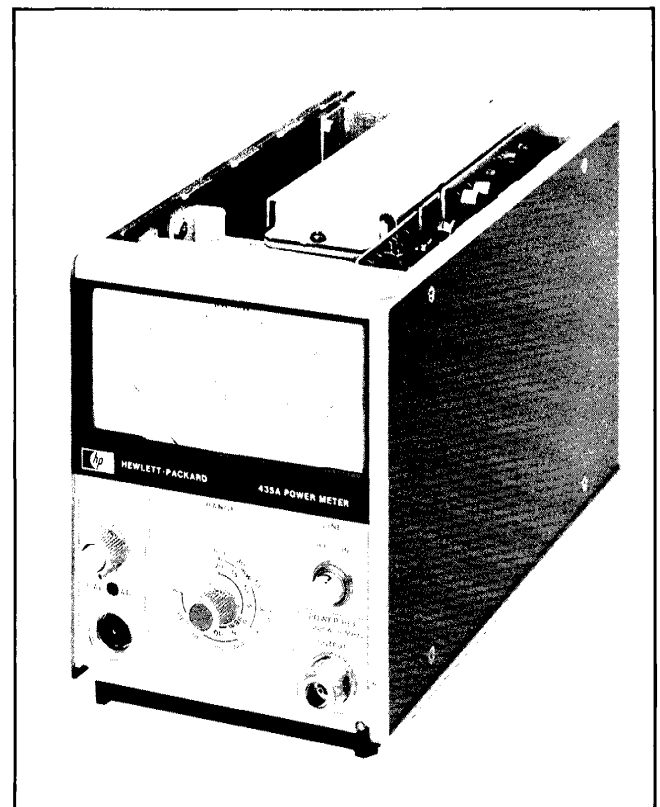

Figure 2-3. 435A With Battery Installed

2-32. Packaging

2-33. Original Packaging. Containers and materials identical to those used in factory packaging are available through Hewlett-Packard offices. If the instrument is being returned to Hewlett-Packard for servicing, attach a tag indicating the type of service required, return address, model number, and full serial number. Also mark the container FRAGILE to assure careful handling. In any correspondence refer to the instrument by model number and full serial number.

2-34. Other Packaging. The following general instructions should be used for re-packaging with commercially available materials:

a. Wrap the instrument in heavy paper or plastic. (If shipping to a Hewlett-Packard office or

service center, attach a tag indicating the type of service required, return address, model number, and full serial number.)

b. Use a strong shipping container. A double-wall carton made of 275-pound test material is adequate.

c. Use enough shock-absorbing material (3 to 4-inch layer) around all sides of the instrument to provide firm cushion and prevent movement inside the container. Protect the control panel with cardboard.

d. Seal the shipping container securely.

e. Mark the shipping container FRAGILE to assure careful handling.

SECTION III OPERATION

INTRODUCTION

This section provides complete operating instructions for the HP Model 435A Power Meter. The instructions consist of: panel features, operator's checks, operating instructions, power measurement accuracy, and operator's maintenance.

PANEL FEATURES

Front and rear panel features of the 435A are shown in Figures 3-2 and 3-3. These figures give a detailed description of the controls, meters, and connectors.

OPERATOR'S CHECKS

Upon receipt of the instrument, or to check the Power Meter for an indication of normal operation, follow the operational procedure shown in Figure 3-4. These procedures are designed to familiarize the operator with the 435A and to give an understanding of the operating capabilities.

OPERATING INSTRUCTIONS

General operating instructions are contained in Figure 3-5. The instructions will familiarize the operator with the basic practices used when operating the 435A.

WARNING

Any interruption of the protective (grounding) conductor (inside or outside the instrument) or disconnecting the protective earth terminal is likely to make this instrument dangerous. Intentional interruption is prohibited.

POWER MEASUREMENT ACCURACY

A power measurement is never free from error or uncertainty. Any RF system has RF losses, mismatch losses, mismatch uncertainty, instrumentation uncertainty and calibration uncertainty. Measurement errors as high as 50% are not only possible, they are highly likely unless the error sources are understood, and as much as possible, eliminated.

3-11. Sources of Error and Measurement Uncertainty

3-12. RF Losses. Some of the RF power that enters the Power Sensor is not dissipated in the power sensing elements. This RF loss is caused by dissipation in the walls of waveguide power sensors, in the center conductor of coaxial power sensors, in the dielectric of capacitors, connections within the sensor, and radiation losses.

3-13. Mismatch. The result of mismatched impedances between the device under test and the power sensor is that some of the power fed to the sensor is reflected before it is dissipated in the load. Mismatches affect the measurement in two ways. First, the initial reflection is a simple loss and is called mismatch loss. Second, the power reflected from the sensor mismatch travels back up the transmission line until it reaches the source. There, most of it is dissipated in the source impedance, but some of it is re-reflected by the source mismatch. The re-reflected power returns to the power sensor and adds to, or subtracts from, the incident power. For all practical purposes, the effect the re-reflected power has upon the power measurement is unpredictable. This effect is called mismatch uncertainty.

3-14. Instrumentation Uncertainty. Instrumentation uncertainty describes the ability of the metering circuits to accurately measure the dc output from the Power Sensor's power sensing device. In the 435A, this error is less than $\pm 1\%$. It is important to realize, however, that a 1% meter does not automatically give 1% overall measurement accuracy.

3-15. Power Reference Uncertainty. The uncertainty of the output level of the Power Reference Oscillator is $\pm 0.70\%$. This reference is normally used to calibrate the system and is, therefore, a part of the system's total measurement uncertainty.

3-16. Cal Factor Switch Resolution Error. The resolution of the CAL FACTOR switch contributes a significant error to the total measurement because the switch has 1% steps. The maximum error possible in each position is $\pm 0.5\%$.

3-17. Corrections for Error**3-18. Calibration Factor and Effective Efficiency.**

The two correction factors basic to power meters are calibration factor and effective efficiency. Effective efficiency is the correction factor for RF losses within the Power Sensor. Calibration factor takes into account the effective efficiency and mismatch losses.

3-19. Calibration factor is expressed as a percentage with 100% meaning the power sensor has no losses. Normally the calibration factor will be 100% at 50 MHz, the operating frequency of the internal reference oscillator.

3-20. The Power Sensors used with the 435A have individually calibrated calibration factor curves placed on their covers. To correct for RF and mismatch losses, simply find the Power Sensor's calibration factor at the measurement frequency from the curve or the table that is supplied with the Power Sensor, and set the CAL FACTOR switch to this value. The measurement error due to this error is now minimized.

3-21. The CAL FACTOR Switch resolution error of $\pm 0.5\%$ may be reduced by one of the following methods:

- 1) Leave the CAL FACTOR switch on 100% after calibration, then make the measurement, and record the reading. Use the reflection coefficient, magnitude and phase angle, from the table supplied with the Power Sensor to calculate the corrected power level.

- 2) Set the CAL FACTOR Switch to the nearest positions above and below the correction factor given on the table. Interpolating between the power levels measured provides the corrected power level.

3-22. Calculating Total Uncertainty

3-23. Certain errors in calculating the total measurement uncertainty have been ignored in this discussion because they are beyond the scope of this manual. Application note AN-64, "*Microwave Power Measurement*", delves deeper into the calculation of power measurement uncertainties. It is available, on request, from your nearest HP office.

3-24. Known Uncertainties. The known uncertainties which account for part of the total power measurement uncertainty are:

- a. Instrumentation uncertainty $\pm 1\%$ or ± 0.05 dB.

- b. Power reference uncertainty $\pm 0.7\%$ or ± 0.03 dB.

- c. CAL FACTOR switch resolution $\pm 0.5\%$ or ± 0.02 dB.

The total uncertainty from these sources is $\pm 2.2\%$ or ± 0.1 dB.

3-25. Calculating Mismatch Uncertainty. Mismatch uncertainty is the result of the source mismatch interacting with the Power Sensor mismatch. The magnitude of uncertainty is related to the magnitudes of the source and Power Sensor reflection coefficients, which can be calculated from VSWR. Figure 3-6 shows how the calculations are to be made and Figure 3-7 illustrates mismatch uncertainty and total calculated uncertainty for two cases. In the first case, the Power Sensor's VSWR = 1.5, and in the second case, the Power Sensor's VSWR = 1.25. In both cases the source has a VSWR of 2.0. The example shows the effect on power measurement accuracy a poorly matched power sensor will have as compared to one with low mismatch.

3-26. A faster, easier way to find mismatch uncertainty is to use the HP Mismatch Error (uncertainty) Limits/Reflectometer Calculator. The calculator may be obtained, on request, from your nearest Hewlett-Packard office by using HP part number 5952-0448.

3-27. The method of calculating measurement uncertainty from the uncertainty in dB is shown by Figure 3-8. This method would be used when the initial uncertainty calculations were made with the Mismatch Error/Reflectometer Calculator.

3-28. OPERATOR'S MAINTENANCE

3-29. The only maintenance responsibilities the operator should normally perform are primary power fuse replacement, LINE switch lamp replacement, and rechargeable battery replacement.

3-30. Battery replacement is the only undertaking that requires tools, and then only a Pozidriv screwdriver is needed.

3-31. Fuses

3-32. The primary power fuse is found within the A5 Power Module Assembly on the Power Meter's rear panel. For instructions on how to change the fuse, refer to the paragraph entitled Line Voltage Selection in Section II.

CAUTION

Make sure that only fuses with the required rated current and of the specified type (normal blow, time delay, etc.) are used for replacement. The use of repaired fuses and the short-circuiting of fuse-holders must be avoided.

3-33. Lamp Replacement

3-34. The lamp is contained in the white plastic lens which doubles for a pushbutton on the LINE switch. When the 435A LINE switch is ON and is being operated by the available line power, the lamp should be illuminated. Figure 3-1 illustrates how to remove and install the lamp.

3-35. Battery Replacement

3-36. If the meter indicates that the battery is discharged by a full downscale reading, and after

charging the battery still will only power the 435A for a short period of time, the battery is probably defective. The replacement battery, BT1 (HP Part Number 1420-0096), may be ordered through the nearest Hewlett-Packard office. Refer to Battery Installation in Section II.

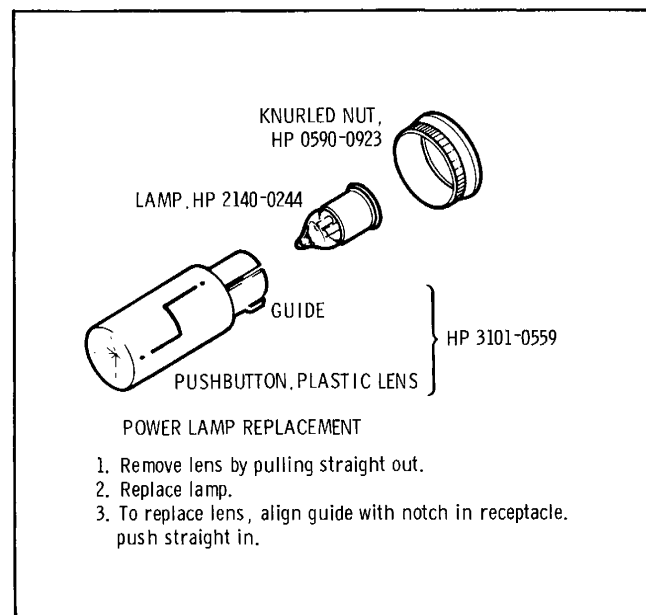
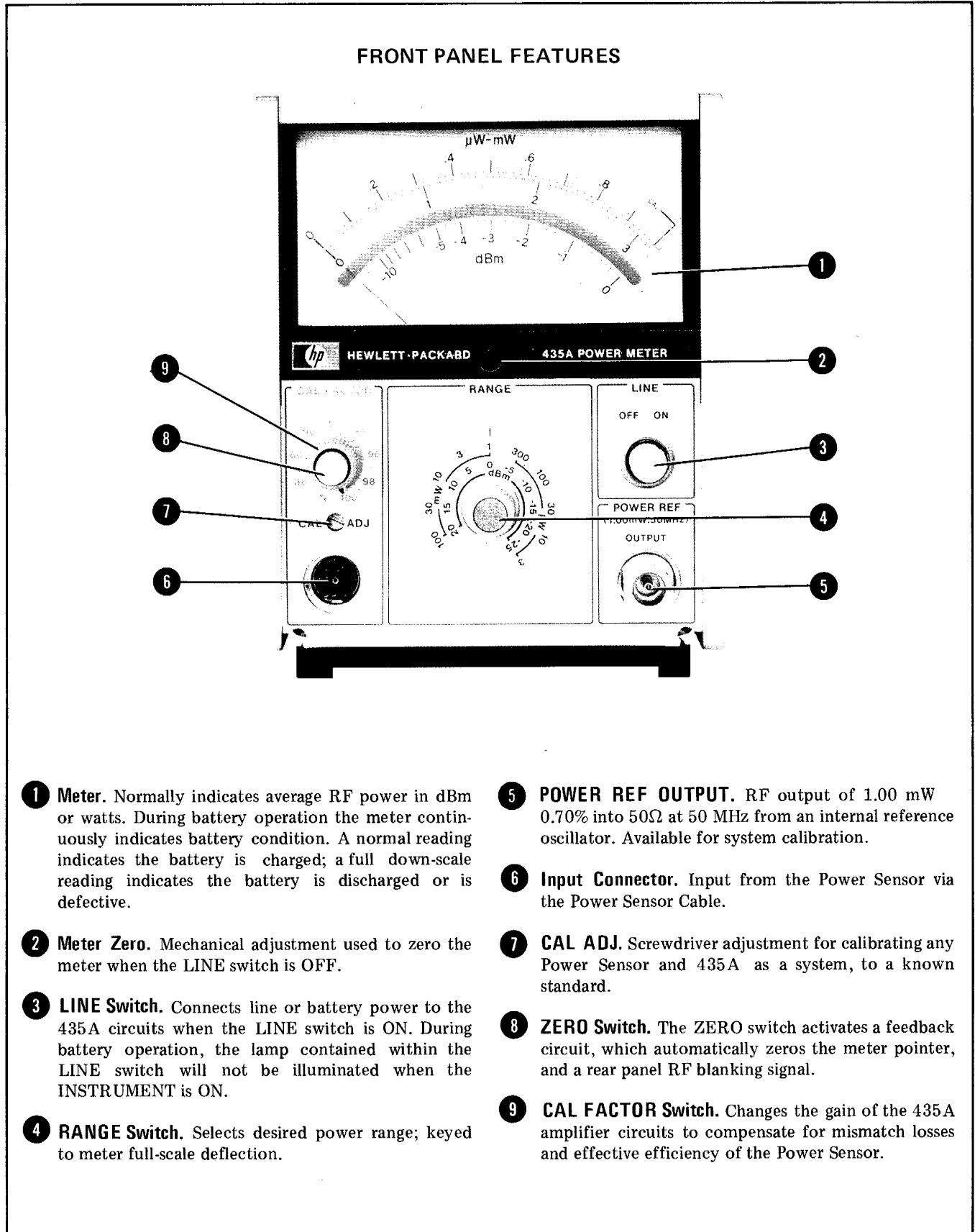

Figure 3-1. Line Switch Lamp Replacement



- 1 **Meter.** Normally indicates average RF power in dBm or watts. During battery operation the meter continuously indicates battery condition. A normal reading indicates the battery is charged; a full down-scale reading indicates the battery is discharged or is defective.
- 2 **Meter Zero.** Mechanical adjustment used to zero the meter when the LINE switch is OFF.
- 3 **LINE Switch.** Connects line or battery power to the 435A circuits when the LINE switch is ON. During battery operation, the lamp contained within the LINE switch will not be illuminated when the INSTRUMENT is ON.
- 4 **RANGE Switch.** Selects desired power range; keyed to meter full-scale deflection.
- 5 **POWER REF OUTPUT.** RF output of 1.00 mW 0.70% into 50Ω at 50 MHz from an internal reference oscillator. Available for system calibration.
- 6 **Input Connector.** Input from the Power Sensor via the Power Sensor Cable.
- 7 **CAL ADJ.** Screwdriver adjustment for calibrating any Power Sensor and 435A as a system, to a known standard.
- 8 **ZERO Switch.** The ZERO switch activates a feedback circuit, which automatically zeros the meter pointer, and a rear panel RF blanking signal.
- 9 **CAL FACTOR Switch.** Changes the gain of the 435A amplifier circuits to compensate for mismatch losses and effective efficiency of the Power Sensor.

Figure 3-2. Front Panel Controls, Connectors, and Indicators

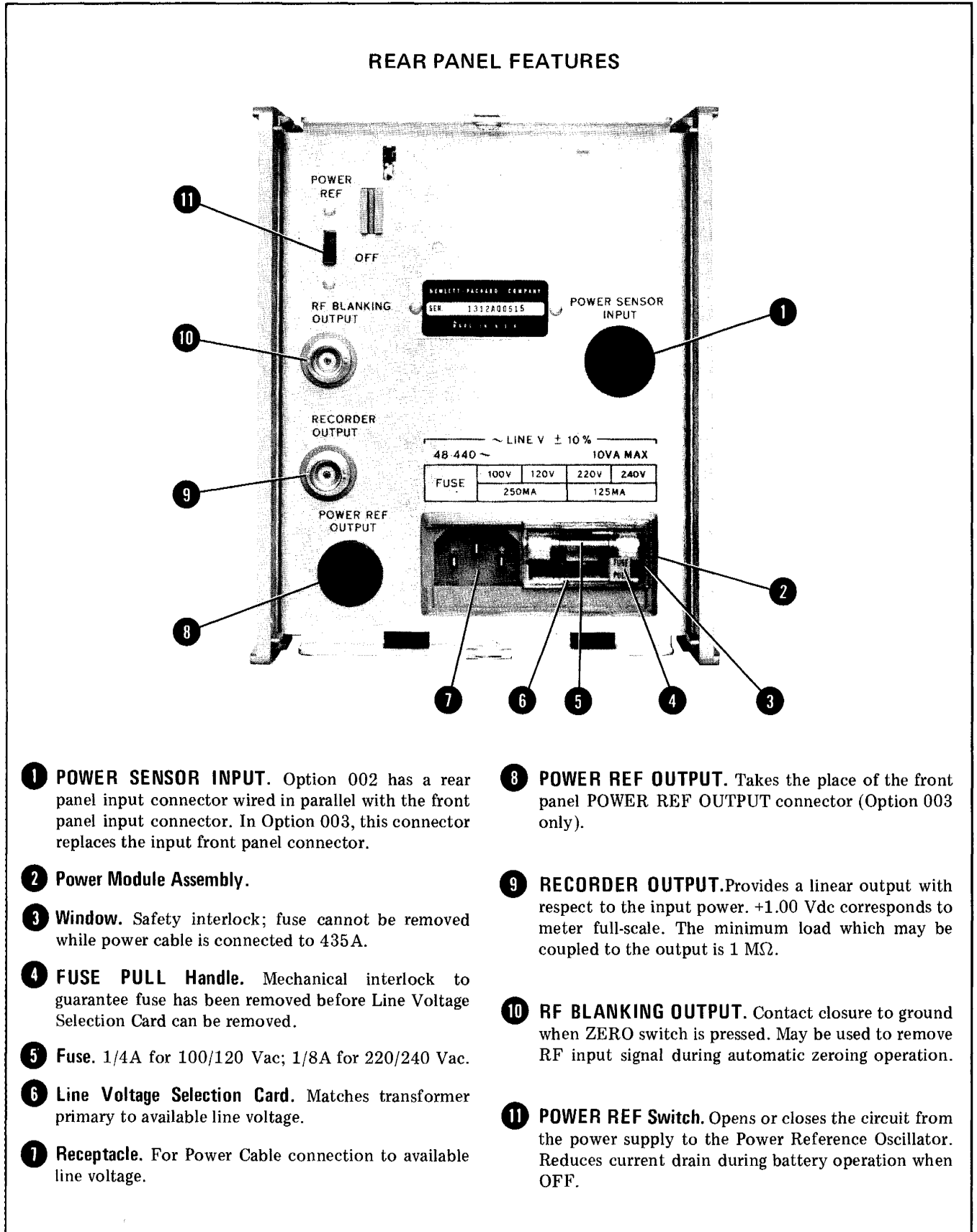

Figure 3-3. Rear Panel Controls, Connectors, and Indicators

OPERATOR'S CHECKS

1. BEFORE SWITCHING ON THIS INSTRUMENT, ensure that the power transformer primary is matched to the available line voltage, the correct fuse is installed, and the safety precautions are taken. See Power Requirements, Line Voltage Selection, Power Cables, and associated warnings and cautions in Section II.

CAUTION

1. BEFORE CONNECTING LINE POWER TO THIS INSTRUMENT, ensure that all devices connected to this instrument are connected to the protective (earth) ground.
2. BEFORE SWITCHING ON THIS INSTRUMENT, ensure that the line power (mains) plug is connected to a three-conductor line power outlet that has a protective (earth) ground. (Grounding one conductor of a two-conductor outlet is not sufficient.)
2. Set the meter indication to zero with the mechanical Meter Zero control. Back the control off slightly.
3. Connect the Power Sensor to the 435A with the Power Sensor Cable.
4. Connect the Power Cable to the power outlet and Power Module receptacles. Set the LINE switch to ON; the lamp within the switch lens should be illuminated.
5. Set the Power Meter controls as follows:

RANGE switch position	3 μ W
CAL FACTOR switch	100%
POWER REF switch	OFF
6. Press the ZERO switch and verify that the meter pointer moves to zero (0) and the RF BLANKING OUTPUT is shorted to ground.
7. Set the RANGE switch to the 3 mW position.
8. Connect the Power Sensor to the POWER REF OUTPUT, set the rear panel POWER REF switch to (ON), and verify the meter indicates approximately a 1 mW output (50 Ω Power Sensor).
9. Step the CAL FACTOR switch through its range noting a small increase in meter reading with each successive step. Reset the CAL FACTOR switch to 100%.
10. Set the RANGE switch to the 1 mW position. Adjust the CAL ADJ control for a full-scale meter reading (50 Ω Power Sensors).
11. Check at the rear panel RECORDER OUTPUT jack for an output of \approx 1 Vdc.
12. To check operation using battery power, disconnect the power cable from the rear panel Power Module receptacle and set the LINE switch to ON (the lamp within the switch lens will not be illuminated). When a power measurement is made, a normal upscale reading indicates normal operation; a full downscale reading indicates the battery is discharged.

Figure 3-4. Operator's Checks

OPERATING INSTRUCTIONS

1. BEFORE SWITCHING ON THIS INSTRUMENT, ensure that the power transformer primary is matched to the available line voltage, the correct fuse is installed, and safety precautions are taken. See Power Requirement, Line Voltage Selection, Power Cables, and associated warnings and cautions in Section II.

CAUTION

1. BEFORE CONNECTING LINE POWER TO THIS INSTRUMENT, ensure that all devices connected to this instrument are connected to the protective (earth) ground.
2. BEFORE SWITCHING ON THIS INSTRUMENT, ensure that the line power (mains) plug is connected to a three-conductor line power outlet that has a protective (earth) ground. (Grounding one conductor of a two-conductor outlet is not sufficient.)
2. Set the meter indication to zero with the mechanical Meter Zero control. Back the control off slightly.
3. Connect the Power Sensor to the 435A with the Power Sensor Cable.
4. Connect the Power Cable to the power outlet and Power Module receptacles. Set the LINE switch to ON; the lamp within the switch lens should be illuminated.
5. Set the Power Meter switches as follows:

RANGE position	3 μ W
CAL FACTOR	100%
POWER REF	OFF

6. Press the ZERO switch, allow 5-seconds for the zeroing operation to take place, and release the switch.
7. Set the RANGE switch to the 1 mW position, connect the Power Sensor to the POWER REF OUTPUT, set the rear panel POWER REF switch to (ON), and adjust the CAL ADJ control for a full-scale reading (50 Ω Power Sensors only). The meter pointer should be aligned with the CAL mark (full-scale reading) on the meter face.
8. Disconnect the Power Sensor from the POWER REF OUTPUT and set the POWER REF switch to OFF.
9. Locate the calibration curve on the Power Sensor cover. Find the CAL FACTOR for the measurement frequency; set the CAL FACTOR switch accordingly.

Figure 3-5. Operating Instructions (1 of 2)

OPERATING INSTRUCTIONS

10. Set the RANGE switch such that full scale is greater than the power level to be measured.

CAUTION

See Operating Precautions in the Power Sensor Operating and Service Manuals for maximum power levels which may be safely coupled to this system. Levels which exceed the limits may damage the Power Sensor, Power Meter or both.

11. Connect the Power Sensor to the RF source. Read the power level in dBm, μ W, or mW on the panel meter.

NOTE

When the battery is being used as the power supply for the Power Meter, an automatic test circuit continually monitors battery condition. When the battery voltage is above a predetermined level, the meter indicates the correct power level. When the voltage drops below the threshold level, the meter reading is full downscale.

Figure 3-5. Operating Instructions (2 of 2)

CALCULATING MEASUREMENT UNCERTAINTY

1. Calculate the reflection coefficient from the given VSWR.

$$\rho = \frac{\text{VSWR} - 1}{\text{VSWR} + 1}$$

Power Sensor #1

Power Sensor #2

Power Source

$$\rho_1 = \frac{1.5 - 1}{1.5 + 1}$$

$$\rho_2 = \frac{1.25 - 1}{1.25 + 1}$$

$$\rho_s = \frac{2.0 - 1}{2.0 + 1}$$

$$= \frac{0.5}{2.5}$$

$$= \frac{0.25}{2.25}$$

$$= \frac{1.0}{3.0}$$

$$= 0.2$$

$$= 0.111$$

$$= 0.333$$

2. Calculate the relative power and percentage power mismatch uncertainties from the reflection coefficients. An initial reference level of 1 is assumed.

Relative Power Uncertainty

$$\text{PU} = [1 \pm (\rho_n \rho_s)]^2$$

$$\text{PU}_1 = \{1 \pm [(0.2)(0.333)]\}^2$$

$$\text{PU}_2 = \{1 \pm [(0.111)(0.333)]\}^2$$

$$= \{1 \pm 0.067\}^2$$

$$= \{1 \pm 0.037\}^2$$

$$= \{1.067\}^2 \text{ and } \{0.933\}^2$$

$$= \{1.037\}^2 \text{ and } \{0.963\}^2$$

$$= 1.138 \quad \text{and} \quad 0.870$$

$$= 1.073 \quad \text{and} \quad 0.928$$

Percentage Power Uncertainty

$$\% \text{PU} = (\text{PU} - 1) 100\% \text{ for } \text{PU} > 1$$

$$\text{and } -(1 - \text{PU}) 100\% \text{ for } \text{PU} < 1$$

$$\% \text{PU}_1 = (1.138 - 1) 100\%$$

$$\text{and } -(1 - 0.870) 100\%$$

$$= (0.138) 100\%$$

$$\text{and } -(0.130) 100\%$$

$$= 13.8\%$$

$$\text{and } -13.0\%$$

$$\% \text{PU}_2 = (1.073 - 1) 100\%$$

$$\text{and } -(1 - 0.928) 100\%$$

$$= (0.073) 100\%$$

$$\text{and } -(0.072) 100\%$$

$$= 7.3\%$$

$$\text{and } -7.2\%$$

Figure 3-6. Calculating Measurement Uncertainties (1 of 2)

CALCULATING MEASUREMENT UNCERTAINTY

3. Calculate the Measurement Uncertainty in dB.

$$\text{MU} = 10 \left[\log_{10} \left(\frac{P_1}{P_0} \right) \right] \text{ dB for } \frac{P_1}{P_0} > 1$$

$$= 10 \left[\log \left(\frac{10P_1}{10P_0} \right) \right] \text{ dB}$$

$$= 10 [\log (10P_1) - \log (10P_0)] \text{ dB for } \frac{P_1}{P_0} < 1$$

$$\text{MU}_1 = 10 \left[\log \left(\frac{1.138}{1} \right) \right] \quad \text{and} \quad 10 [\log (10) (0.870) - \log (10) (1)]$$

$$= 10 [0.056] \quad \text{and} \quad 10 [\log (8.70) - \log (10)]$$

$$\text{and} \quad 10 [0.94 - 1]$$

$$\text{and} \quad 10 [-0.060]$$

$$= +0.56 \text{ dB} \quad \text{and} \quad -0.60 \text{ dB}$$

$$\text{MU}_2 = 10 \left[\log \left(\frac{1.073}{1} \right) \right] \quad \text{and} \quad 10 [\log (10) (0.928) - \log (10) (1)]$$

$$= 10 [0.031] \quad \text{and} \quad 10 [\log (9.28) - \log (10)]$$

$$\text{and} \quad 10 [0.968 - 1]$$

$$\text{and} \quad 10 [-0.032]$$

$$= +0.31 \text{ dB} \quad \text{and} \quad -0.32 \text{ dB}$$

Figure 3-6. Calculating Measurement Uncertainties (2 of 2)

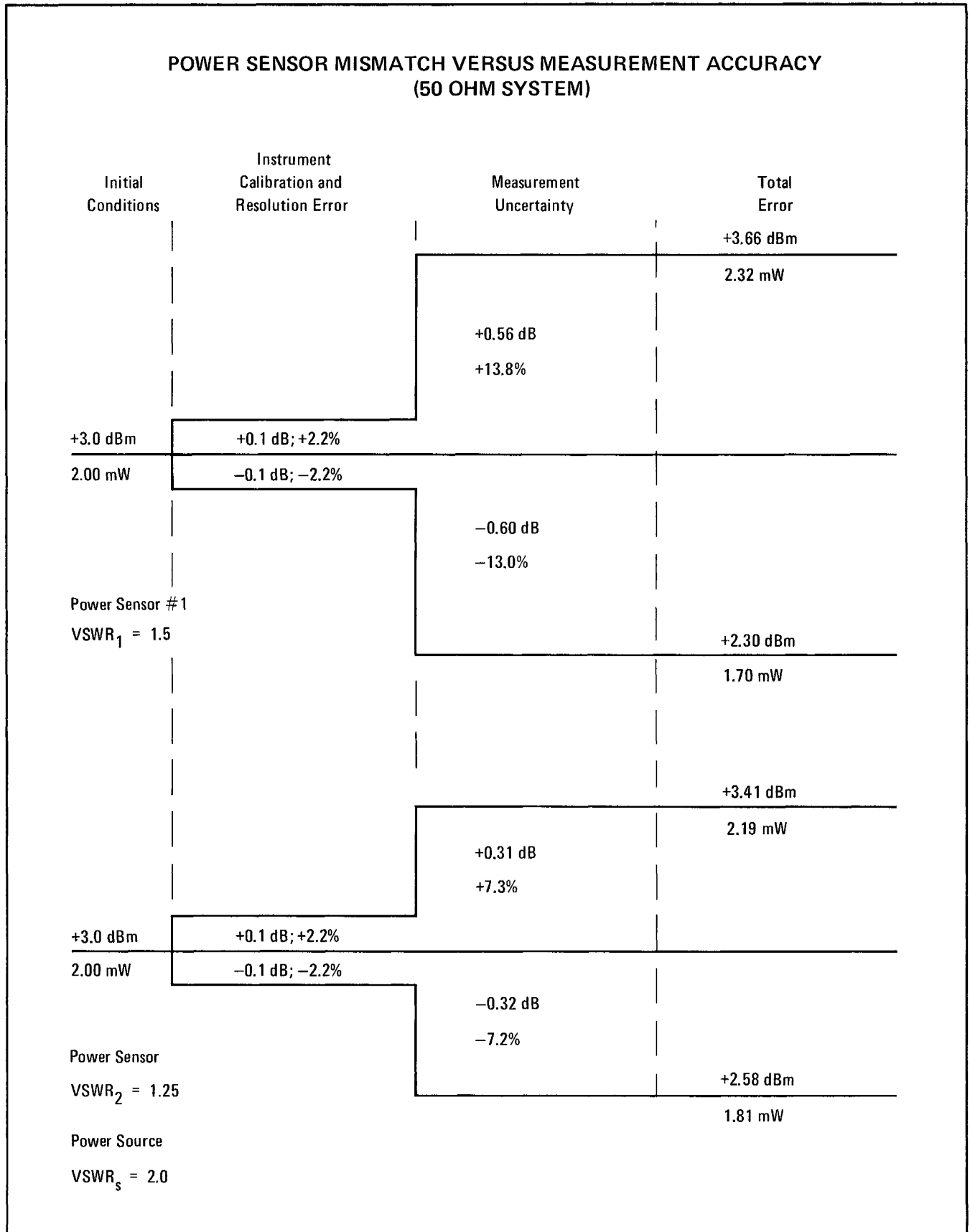

Figure 3-7. The Effect of Power Sensor Mismatch on Measurement Accuracy

CALCULATING MEASUREMENT UNCERTAINTY

1. For this example the known values are: source VSWR, 2.2 and power sensor VSWR, 1.16. From the Mismatch Error Calculator the mismatch uncertainty is found to be +0.24, -0.25 dB.
2. Add the known uncertainties from paragraph 3-26, (± 0.10 dB). Our total measurement uncertainty is +0.34, -0.35 dB.
3. Calculate the relative measurement uncertainty from the following formula:

$$\text{dB} = 10 \log \left(\frac{P_1}{P_0} \right)$$

$$\frac{\text{dB}}{10} = \log \left(\frac{P_1}{P_0} \right)$$

$$\frac{P_1}{P_0} = \log^{-1} \left(\frac{\text{dB}}{10} \right)$$

If dB is positive then:
 $P_1 > P_0$; let $P_0 = 1$

$$\begin{aligned} \text{MU} = P_1 &= \log^{-1} \left(\frac{\text{dB}}{10} \right) \\ &= \log^{-1} \left(\frac{0.34}{10} \right) \\ &= 1.081 \end{aligned}$$

If dB is negative then:
 $P_1 < P_0$; let $P_1 = 1$

$$\begin{aligned} \text{MU} = P_0 &= \frac{1}{\log^{-1} \left(\frac{\text{dB}}{10} \right)} \\ &= \frac{1}{\log^{-1} \left(\frac{0.35}{10} \right)} \\ &= \frac{1}{1.082} \\ &= 0.923 \end{aligned}$$

4. Calculate the percentage Measurement Uncertainty.

For $P_1 > P_0$

$$\begin{aligned} \% \text{MU} &= (P_1 - P_0) 100 \\ &= (1.081 - 1) 100 \\ &= +8.1\% \end{aligned}$$

For $P_1 < P_0$

$$\begin{aligned} \% \text{MU} &= -(P_1 - P_0) 100 \\ &= -(1 - 0.923) 100 \\ &= -7.7\% \end{aligned}$$

Figure 3-8. Calculating Measurement Uncertainty (Uncertainty in dB Known)

SECTION IV PERFORMANCE TESTS

4-1. INTRODUCTION

4-2. The procedures in this section test the electrical performance of the HP Model 435A using the specifications of Table 1-1 as performance standards. All tests can be performed without access to the interior of the instrument. A simpler operational test is included in Section III under Operator's Checks.

4-3. EQUIPMENT REQUIRED

4-4. Equipment required for the performance tests is listed in Table 1-2, Recommended Test Equipment. Any equipment that satisfies the critical specifications given in the table may be substituted for the recommended model(s).

4-5. TEST RECORD

4-6. Results of the performance tests may be tabulated on the Test Record at the end of the test procedures. The Test Record lists all of the tested specifications and their acceptable limits. Test results recorded at incoming inspection can be used for comparison in periodic maintenance, troubleshooting, and after repairs or adjustments.

4-7. PERFORMANCE TESTS

4-8. The performance tests given in this section are suitable for incoming inspection, troubleshooting, or preventative maintenance. During any performance test, all shields and connecting hardware must be in place. The tests are designed to verify published instrument specifications. Perform the tests in the order given and record the data on the test card and/or in the data spaces provided at the end of each procedure.

NOTE

The 485A must have a half-hour warmup and the line voltage must be within +5%, -10% of nominal if the performance tests are to be considered valid.

4-9. Each test is arranged so that the specification is written as it appears in Table 1-1. Next, a description of the test and any special instructions or problem areas are included. Each test that requires test equipment has a setup drawing and a list of the required equipment. The initial steps of each procedure give control settings required for that particular test.

PERFORMANCE TESTS

4-10. POWER REFERENCE OUTPUT TEST

SPECIFICATION:

±0.70% (1 mW at 50 MHz, traceable to the National Bureau of Standards).

DESCRIPTION:

A test normally cannot be performed to check the accuracy of the POWER REF OUTPUT level due to the inaccuracy of power measurement systems. To set the output level Hewlett-Packard employs a special system accurate to ±0.5% and traceable to the National Bureau of Standards. A transfer error of ±0.2% is introduced when the level is set, therefore the total error of the reference level is ±0.7%. Hewlett-Packard

NOTES

1. A system with total error of ±0.7% or less, and traceable to NBS (including calibration transfer error) may be used to set the POWER REF OUTPUT level.
 2. The 435A may be returned to Hewlett-Packard through the nearest HP office to have the reference oscillator checked and/or adjusted. Refer to Section II, PACKAGING.
-

PERFORMANCE TESTS

4-11. ZERO CARRYOVER TEST

SPECIFICATION:

$\pm 0.5\%$ (0 ± 5 mVdc) on all ranges when zeroed in the most sensitive range.

DESCRIPTION:

After the 435A is initially zeroed, the change in the meter reading is monitored at the RECORDER OUTPUT as the instrument is stepped through its ranges. The meter readings take into account noise and drift because zero carryover and the noise drift readings cannot be separated.

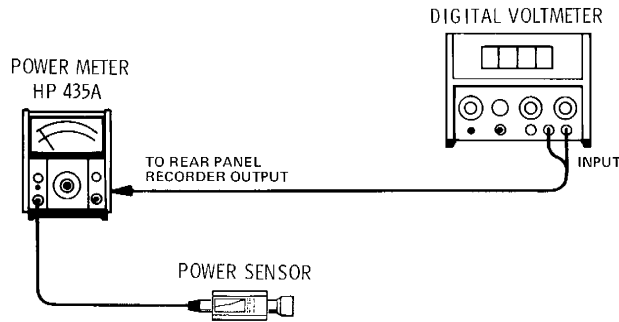

Figure 4-1. Zero Carryover Test Setup

EQUIPMENT:

Digital Voltmeter HP 3480A/3482A

PROCEDURE:

1. Set the DVM RANGE control to 100 mVdc.
2. Set the Power Meter switches as follows:

CAL FACTOR	100%
RANGE position	3 μ W
POWER REF (rear panel)	OFF
3. Connect the equipment as shown in Figure 4-1.
4. Press the front panel ZERO switch and wait for the meter indicator's position to stabilize. Verify that the DVM reads 0 ± 0.9 mVdc. Release the ZERO switch.
5. Verify that the RECORDER OUTPUT falls within the limits shown on the table for each range. Record the readings.

PERFORMANCE TESTS

4-11. ZERO CARRYOVER TEST (cont'd)

RANGE Switch Position	Results			RANGE Switch Position	Results		
	Min	Actual	Max		Min	Actual	Max
	mVdc	mVdc	mVdc		mVdc	mVdc	mVdc
3 μ W	-15	_____	+15	1 mW	-5	_____	+5
10 μ W	-17	_____	+17	3 mW	-5	_____	+5
30 μ W	-14	_____	+14	10 mW	-5	_____	+5
100 μ W	-11	_____	+11	30 mW	-5	_____	+5
300 μ W	- 8	_____	+ 8	100 mW	-5	_____	+5

4-12. INSTRUMENTATION ACCURACY TEST WITHOUT CALIBRATOR

SPECIFICATION:

$\pm 1\%$ of full scale on all ranges (0 to 55° C).

DESCRIPTION:

A well regulated dc voltage is coupled through a voltage divider network to the sampling gate circuit of the power sensor. The CAL ADJ control is used to set the meter to full scale on the 1 mW range position. Accuracy on the other ranges is verified within $\pm 1\%$ plus noise and drift.

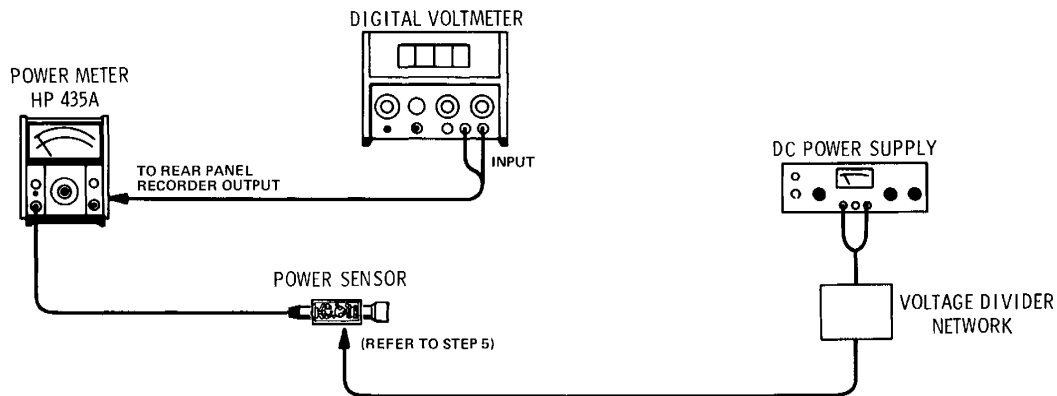

Figure 4-2. Instrumentation Accuracy Test Setup Without Calibrator

EQUIPMENT:

- Digital Voltmeter HP 3480A/3482A
- Power Supply HP 6204B
- Voltage Divider Network (See Figure 1-2).

PERFORMANCE TESTS

4-12. INSTRUMENTATION ACCURACY TEST WITHOUT CALIBRATOR (cont'd)

PROCEDURE:

1. Remove the top cover of the Power Sensor. Refer to paragraph on REPAIR in the Power Sensor manual.
2. Set the DVM Range switch to 1000 mVdc.
3. Set the Power Meter RANGE switch to the 3 μ W position, press the ZERO switch and release after 5 seconds.
4. Set the Power Meter and Voltage Divider Network range switches to the 1 mW position; set the Power Supply controls for a +15.0 Vdc output.

NOTE

The Voltage Divider Network is shown in Figure 1-2.

5. Connect the equipment as shown in Figure 4-2. The dc output voltage from the Voltage Divider Network is coupled to the Power Sensor's sampling gate input (positive output of power sensing device). Refer to the schematic and the component location diagram in the Power Sensor manual.
6. With the Power Meter CAL ADJ control, set the DVM reading to 1000 ± 2 mVdc.
7. Change the Power Meter and Voltage Divider Range switches in sequence to each range position; verify that the DVM readings fall within the tolerances shown in the following table.

CAUTION

To avoid damage to the meter, set the RANGE control of the Power Meter first when changing to a higher range. Select the Voltage Divider Network range first when changing to a lower range.

RANGE Switch Position	Results			RANGE Switch Position	Results		
	Min	Actual	Max		Min	Actual	Max
	mVdc	mVdc	mVdc		mVdc	mVdc	mVdc
3 μ W	+975	_____	+1025	1 mW	+998	_____	+1002
10 μ W	+978	_____	+1022	3 mW	+990	_____	+1010
30 μ W	+981	_____	+1019	10 mW	+990	_____	+1010
100 μ W	+984	_____	+1016	30 mW	+990	_____	+1010
300 μ W	+987	_____	+1013	100 mW	+990	_____	+1010

PERFORMANCE TESTS

4-13. INSTRUMENTATION ACCURACY TEST WITH CALIBRATOR

SPECIFICATION:

± 1% of full scale on all ranges (0 to 55° C).

DESCRIPTION:

Instrumentation accuracy is verified by coupling a full-scale reference input from the HP 11683A Calibrator to the 435A on each range. Verify that the RECORDER OUTPUT level is within ±1% plus noise and drift.

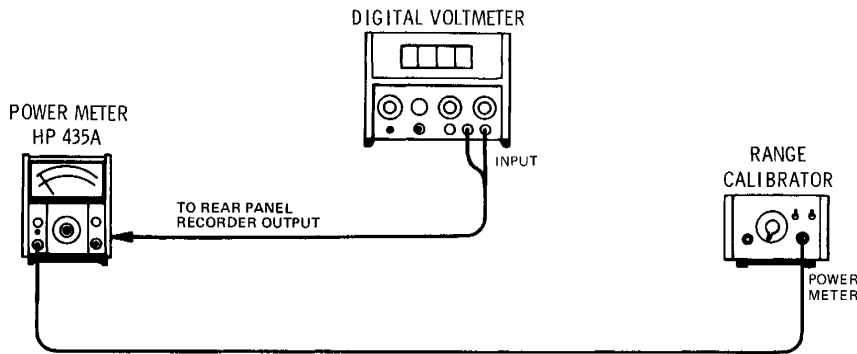

Figure 4-3. Instrumentation Accuracy Test Setup With Calibrator

EQUIPMENT:

Digital Voltmeter	HP 3480A/3482A
Range Calibrator	HP 11683A

PROCEDURE:

1. Set the 11683A RANGE switch to 1 mW, the FUNCTION switch to CALIBRATE, and the POLARITY switch to NORMAL.
2. Set the 435A RANGE switch to the 1 mW position.
3. Set the DVM Range switch to 1000 mVdc.
4. Connect the equipment as shown in Figure 4-3.
5. The front panel CAL ADJ control is adjusted to provide a reading of 1000 ± 2 mVdc on the DVM.

CAUTION

To avoid damage to the meter, set the Calibrator's FUNCTION control to STANDBY while changing the RANGE control settings on the Power Meter and Calibrator.

6. Set the 435A RANGE switch to each possible position in turn. Set the 11683A RANGE switch to the same position and verify that the DVM reading, which includes noise and drift, is within the limits shown in the table on the following page.

PERFORMANCE TESTS

4.13. INSTRUMENTATION ACCURACY TEST (WITH CALIBRATOR) (cont'd)

RANGE Switch Position	Results			RANGE Switch Position	Results		
	Min	Actual	Max		Min	Actual	Max
3 μ W	mVdc +975	mVdc _____	mVdc +1025	1 mW	mVdc +998	mVdc _____	mVdc +1002
10 μ W	+978	_____	+1022	3 mW	+990	_____	+1010
30 μ W	+981	_____	+1019	10 mW	+990	_____	+1010
100 μ W	+984	_____	+1016	30 mW	+990	_____	+1010
300 μ W	+987	_____	+1013	100 mW	+990	_____	+1010

Table 4-1. Performance Test Record

Hewlett-Packard Model 435A Power Meter Serial Number _____					Tested By _____ Date _____				
Para. No.	Test	Results							
		Min.	Actual	Max.					
4-11.	Zero Carryover	mVdc	mVdc	mVdc					
	3 μ W	-15	_____	+15					
	10 μ W	-17	_____	+17					
	30 μ W	-14	_____	+14					
	100 μ W	-11	_____	+11					
	300 μ W	-8	_____	+8					
	1 mW	-5	_____	+5					
	3 mW	-5	_____	+5					
	10 mW	-5	_____	+5					
	30 mW	-5	_____	+5					
100 mW	-5	_____	+5						
4-12. or 4-13.	Instrumentation Accuracy	mVdc	mVdc	mVdc					
	3 μ W	+975	_____	+1025					
	10 μ W	+978	_____	+1022					
	30 μ W	+981	_____	+1019					
	100 μ W	+984	_____	+1016					
	300 μ W	+987	_____	+1013					
	1 mW	+998	_____	+1002					
	3 mW	+990	_____	+1010					
	10 mW	+990	_____	+1010					
	30 mW	+990	_____	+1010					
100 mW	+990	_____	+1010						

SECTION V ADJUSTMENTS

INTRODUCTION

This section describes the adjustments which return the Power Meter to peak operating condition after repairs are completed.

If the adjustments are to be considered valid, the Power Meter must have a half hour warmup and the line voltage must be within +5 to -10% of nominal.

The adjustment procedure entitled "Power Meter Adjustments With 50Ω Power Sensor" is to be performed only when the HP Model 11683A Power Calibrator is not available.

SAFETY CONSIDERATIONS

Although this instrument has been designed in accordance with international safety standards, this manual contains information, cautions, and warnings which must be followed to ensure safe operation and to retain the instrument in safe condition (see Sections II and III). Service and adjustments should be performed only by qualified personnel.

WARNING

Any interruption of the protective (grounding) conductor (inside or outside the instrument) or disconnection of the protective earth terminal is likely to make the instrument dangerous. Intentional interruption is prohibited.

Any adjustment, maintenance, and repair of an opened instrument under voltage should be avoided as much as possible and, when inevitable, should be carried out only by a skilled person who is aware of the hazard involved.

Capacitors inside the instrument may still be charged even if the instrument has been disconnected from its source of supply.

Make sure that only fuses with the required current and of the specified type (normal, time delay, etc.) are used for replacement. The use of repaired fuses and the shortcircuiting of breakers must be avoided.

5-10. Whenever it is likely that the protection offered by fuses has been impaired, the instrument must be made inoperative and be secured against any unintended operation.

WARNING

Adjustments described herein are performed with power supplied to the instrument while protective covers are removed. Energy available at many points may, if contacted, result in personal injury.

5-11. EQUIPMENT REQUIRED

5-12. The test equipment required for the adjustment procedures is listed in Table 1-2, Recommended Test Equipment. The critical specifications of substitute test instruments must meet or exceed the standards listed in the table if the 435A is to meet the standards set forth in Table 1-1, Specifications.

5-13. FACTORY SELECTED COMPONENTS

5-14. Factory selected components are indicated on the schematic and replaceable parts list with an asterisk immediately following the reference designator. The nominal value of the component is listed. Table 5-1 lists the parts by reference designator and provides an explanation of how the component is selected, the normal value range, and a reference to the appropriate service sheet. The Manual Changes supplement will update any changes to factory selected component information.

5-15. ADJUSTMENT LOCATIONS

5-16. All the adjustments for the 435A are contained on the A4 assembly except the front panel CAL ADJ control and POWER REF OUTPUT level control. The last foldout in this manual contains a table which cross-references all pictorial and schematic locations of the adjustment controls. The accompanying figure shows the locations of the adjustable controls, assemblies, and chassis-mounted parts.

Table 5-1. Factory Selected Components

Reference Designator	Selected For	Normal Value Range	Service Sheet
A4R66	A fullscale reading (100mW) with an accurate 100 mW input after the adjustment procedure has been completed. Hewlett-Packard recommends using a Model 11683A Calibrator to achieve the needed accuracy for selecting this resistor. The DVM reading at the 435A's RECORDER OUTPUT will be 1000 ± 3 mVdc with the correct resistor in place.	150K to 250K	2
A3R15	A POWER REF OUTPUT of 1 mW when the LEVEL control is full ccw. Needed if the highest output level possible is <1 mW.	50K to 200K	4
A3R16	A POWER REF OUTPUT of 1 mW when the LEVEL control is full cw. Needed if the lowest output level possible is >1 mW.	50K to 200K	4

ADJUSTMENTS

5-17. POWER METER ADJUSTMENTS WITH 50 Ω POWER SENSOR

REFERENCE:

Service Sheets 2 and 3.

DESCRIPTION:

1. The Balance control is centered to remove the dc offset introduced by the Auto Zero circuit.
2. The DC Offset control removes any dc voltage introduced by the DC Amplifier.
3. The CAL ADJ control is used to set a level of +1.00 Vdc at the rear panel RECORDER OUTPUT jack with a full scale input.
4. The Meter control sets the meter reading to full scale when the RECORDER OUTPUT level is +1.00 Vdc.
5. The Auto Zero Offset adjustment removes any dc voltage introduced by the Auto Zero circuits when the ZERO switch is pressed.
6. The Balance control centers the Auto Zero circuits output voltage range. The Auto Zero output is forced to its negative extreme and the Balance control sets the RECORDER OUTPUT voltage below center-range (+1.00 Vdc) by one-half the total range.

 ADJUSTMENTS

5-17. POWER METER ADJUSTMENTS WITH 50Ω POWER SENSOR (cont'd)

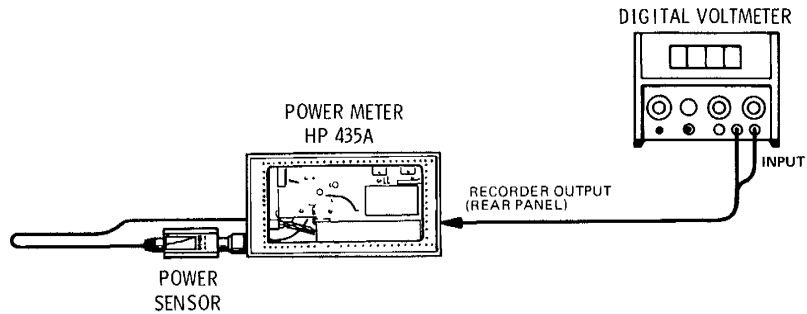

Figure 5-1. Power Meter Adjustment Setup without Calibrator

EQUIPMENT:

Digital Voltmeter HP 3480A/3482A

PROCEDURE:

1. Set the LINE switch to OFF, wait a few seconds, and adjust the mechanical meter zero control for a meter reading of zero.
2. Set the DVM Range switch to 1000 mVdc.
3. Set the Power Meter CAL FACTOR switch to 100%.
4. Remove the right side cover of the 435A and connect the equipment as shown in Figure 5-1.
5. Set the LINE switch to (ON).
6. Center the Power Meter Balance Control A4R46.
7. Set the Power Meter RANGE switch to the 100 mW position, and adjust A4R32, DC Offset control, for a DVM reading of 0 ± 0.2 mVdc.
8. Set the RANGE switch to the 1 mW position and the rear panel POWER REF switch to (ON).
9. Adjust the front panel CAL ADJ control to read 1000 ± 1 mVdc on the DVM.
10. Adjust A4R35, Meter control, to give a full-scale meter reading.
11. Set the rear panel POWER REF switch to OFF; the RANGE switch to the $3 \mu\text{W}$ position.
12. Press the front panel ZERO switch, hold it in, and adjust the Auto Zero Offset control A4R42 for a DVM reading of 0 ± 1 mVdc.
13. Set the RANGE switch to the 1 mW position; set the rear panel POWER REF switch to (ON).

 ADJUSTMENTS

5-17. POWER METER ADJUSTMENTS WITH 50Ω POWER SENSOR (cont'd)

14. Press the ZERO switch, hold it in, and adjust the Balance Adjustment, A4R46, until the DVM reading is 961 ± 1 mVdc.
 15. Set the rear panel POWER REF switch to OFF and disconnect the Power Sensor from the POWER REF OUTPUT.
-

5-18. POWER METER ADJUSTMENTS WITH CALIBRATOR

REFERENCE:

Service Sheets 2 and 3.

DESCRIPTION:

1. The Balance control is centered to remove the dc offset introduced by the Auto Zero circuits.
2. The DC Offset control removes any dc voltage introduced by the DC Amplifier.
3. The CAL ADJ control is used to set a level of +1.00 Vdc at the rear panel RECORDER OUTPUT jack with a full scale input from the Model 11683A Range Calibrator.
4. The Meter control sets the meter reading to full scale when the RECORDER OUTPUT level is +1.00 Vdc.
5. The Auto-Zero Offset adjustment removes any dc voltage that is introduced by the auto-zero circuits while the ZERO switch is pressed.
6. The Balance control centers the Auto-zero circuit's output voltage range. The Auto-zero output is forced to its negative extreme. The Balance Control sets the RECORDER OUTPUT voltage below the center (+1.00 Vdc) by one-half the total possible voltage swing.

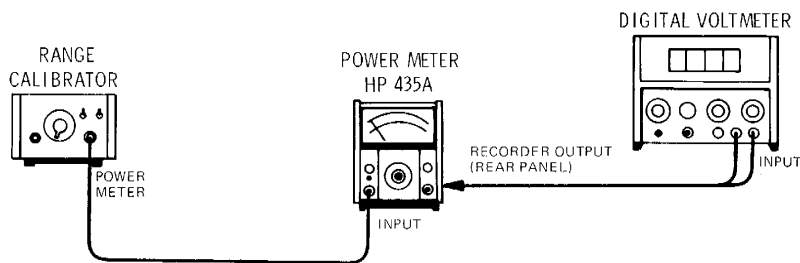

Figure 5-2. 435A Adjustment Setup With Calibrator

EQUIPMENT:

Digital Voltmeter	HP 3480A/3482A
Range Calibrator	HP 11683A (ONLY)

ADJUSTMENTS

5-18. POWER METER ADJUSTMENTS WITH CALIBRATOR (cont'd)

PROCEDURE:

1. Set the Power Meter LINE switch to OFF and adjust the mechanical Meter Zero control for a meter reading of zero.

2. Set the Power Meter switches as follows:

CAL FACTOR	100%
RANGE position	100 mW
POWER REF	OFF

3. Set the Range Calibrator RANGE switch to 1 mW, FUNCTION switch to STANDBY, and POLARITY switch to NORMAL.

4. Set the DVM Range switch to 1000 mVdc.

5. Remove the right side cover of the Power Meter, connect the equipment as shown in Figure 5-2, and set the LINE switch to ON.

6. Center the Power Meter Balance control, A4R46.

7. Adjust A4R32 DC Offset control for a DVM reading of 0 ± 0.2 mVdc.

8. Set the Power Meter RANGE switch to the 1 mW position.

9. Set the Range Calibrator FUNCTION switch to CALIBRATE.

10. Adjust the Power Meter front panel CAL ADJ control for a DVM reading of 1000 ± 1 mVdc.

11. Adjust the Meter control A4R35 for a full-scale meter reading.

12. Set the Range Calibrator FUNCTION switch to STANDBY.

13. Set the Power Meter RANGE switch to the $3 \mu\text{W}$ position, press and hold the ZERO switch, and adjust A4R42 Auto Zero Offset control for a DVM reading of 0 ± 1 mVdc.

14. Set the Power Meter RANGE switch to the 1 mW position; set the Range Calibrator's FUNCTION switch to CALIBRATE.

15. Press and hold the Power Meter ZERO switch and adjust the A4R46 Balance control for a DVM reading of 961 ± 3 mVdc.

16. Set the Range Calibrator FUNCTION switch to STANDBY.

SECTION VI REPLACEABLE PARTS

6-1. INTRODUCTION

6-2. This section contains information for ordering replacement parts for the HP Model 435A Power Meter. Table 6-1 lists abbreviations used in the parts list and throughout the manual. Table 6-2 lists all replaceable parts in reference designator order. Table 6-3 contains the names and addresses that correspond to the manufacturer's code number.

6-3. ABBREVIATIONS

6-4. Table 6-1 gives a list of abbreviations used in the parts list, schematics, and throughout the manual. In some cases, two forms of the abbreviations are given, one all capital letters and one partial or no capitals. This occurs because the abbreviations in the parts list are always all capitals. However, in the schematics and other parts of the manual, other abbreviation forms are used with both lower case and upper case letters.

6-5. REPLACEABLE PARTS LIST

6-6. Table 6-2 is the list of replaceable parts and is organized as follows:

- a. Electrical assemblies and their components in alpha-numeric order by reference designation.
- b. Chassis-mounted parts in alpha-numeric order by reference designation.
- c. Miscellaneous parts.
- d. Illustrated parts breakdown.

The information given for each part consists of the following:

- a. The Hewlett-Packard part number.

- b. The total quantity (Qty) used in the instrument.

- c. The description of the part.

- d. Typical manufacturer of the part in a five-digit code.

- e. Manufacturer code number for the part.

The total quantity for each part is given only once; at the first appearance of the part number in the list.

6-7. ORDERING INSTRUCTIONS

6-8. To order a part listed in the replaceable parts table, quote the Hewlett-Packard part number, indicate quantity required, and address the order to the nearest Hewlett-Packard office.

6-9. To order a part that is not listed in the replaceable parts table, include the instrument model number, instrument serial number, the description and function of the part, and the number of parts required. Address the order to the nearest Hewlett-Packard office.

6-10. PARTS PROVISIONING

6-11. Stocking spare parts for an instrument is often done to insure quick return to service after a malfunction occurs. Hewlett-Packard has a "Spare Parts Kit" available for this purpose. The kit consists of selected replaceable assemblies and components for this instrument. The contents of the kit and the "Recommended Spares" list are based on failure reports and repair data, and parts support for one year. A complimentary "Recommended Spares" list for this instrument may be obtained on request, and the "Spare Parts Kit" may be ordered through your nearest Hewlett-Packard office.

Table 6-1. Reference Designations and Abbreviations (1 of 2)

REFERENCE DESIGNATIONS

A assembly	E miscellaneous electrical part	P electrical connector (movable portion); plug	U integrated circuit; microcircuit
AT attenuator; isolator; termination	F fuse	Q transistor: SCR; triode thyristor	V electron tube
B fan; motor	FL filter	R resistor	VR voltage regulator; breakdown diode
BT battery	H hardware	RT thermistor	W cable; transmission path; wire
C capacitor	HY circulator	S switch	X socket
CP coupler	J electrical connector (stationary portion); jack	T transformer	Y crystal unit (piezo-electric or quartz)
CR diode; diode thyristor; varactor	K relay	TB terminal board	Z tuned cavity; tuned circuit
DC directional coupler	L coil; inductor	TC thermocouple	
DL delay line	M meter	TP test point	
DS annunciator; signaling device (audible or visual); lamp; LED	MP miscellaneous mechanical part		

ABBREVIATIONS

A ampere	COEF coefficient	EDP electronic data processing	INT internal
ac alternating current	COM common	ELECT electrolytic	kg kilogram
ACCESS accessory	COMP composition	ENCAP encapsulated	kHZ kilohertz
ADJ adjustment	COMPL complete	EXT external	kΩ kilohm
A/D analog-to-digital	CONN connector	F farad	kV kilovolt
AF audio frequency	CP cadmium plate	FET field-effect transistor	lb pound
AFC automatic frequency control	CRT cathode-ray tube	F/F flip-flop	LC inductance-capacitance
AGC automatic gain control	CTL complementary transistor logic	FH flat head	LED light-emitting diode
AL aluminum	CW continuous wave	FIL H fillister head	LF low frequency
ALC automatic level control	cw clockwise	FM frequency modulation	LG long
AM amplitude modulation	cm centimeter	FP front panel	LH left hand
AMPL amplifier	D/A digital-to-analog	FREQ frequency	LIM limit
APC automatic phase control	dB decibel	FXD fixed	LIN linear taper (used in parts list)
ASSY assembly	dBm decibel referred to 1 mW	g gram	lin linear
AUX auxiliary	dc direct current	GE germanium	LK WASH lock washer
avg average	deg degree (temperature interval or difference)	GHZ gigahertz	LO low; local oscillator
AWG American wire gauge	° degree (plane angle)	GL glass	LOG logarithmic taper (used in parts list)
BAL balance	°C degree Celsius (centigrade)	GRD ground(ed)	log logarithm(ic)
BCD binary coded decimal	°F degree Fahrenheit	H henry	LPF low pass filter
BD board	°K degree Kelvin	HET heterodyne	LV low voltage
BE CU beryllium copper	DEPC deposited carbon	HEX hexagonal	m meter (distance)
BFO beat frequency oscillator	DET detector	HD head	mA milliampere
BH binder head	diam diameter	HDW hardware	MAX maximum
BKDN breakdown	DIA diameter (used in parts list)	HF high frequency	MΩ megohm
BP bandpass	DIFF AMPL differential amplifier	HG mercury	MEG meg (10 ⁶) (used in parts list)
BPF bandpass filter	div division	HI high	MET FLM metal film
BRS brass	DPDT double-pole, double-throw	HP Hewlett-Packard	MET OX metallic oxide
BWO backward-wave oscillator	DR drive	HPF high pass filter	MF medium frequency; microfarad (used in parts list)
CAL calibrate	DSB double sideband	HR hour (used in parts list)	MFR manufacturer
cw counter-clockwise	DTL diode transistor logic	HV high voltage	mg milligram
CER ceramic	DVM digital voltmeter	HZ Hertz	MHZ megahertz
CHAN channel	ECL emitter coupled logic	IC integrated circuit	mH millihenry
cm centimeter	EMF electromotive force	ID inside diameter	mho mho
CMO cabinet mount only		IF intermediate frequency	MIN minimum
COAX coaxial		IMPG impregnated	min minute (time)
		in inch minute (plane angle)
		INCD incandescent	MIN AT miniature
		INCL include(s)	mm millimeter
		INP input	
		INS insulation	

NOTE

All abbreviations in the parts list will be in upper-case.

Table 6-1. Reference Designations and Abbreviations (2 of 2)

MOD modulator	OD outside diameter	PWV peak working voltage	TD time delay
MOM momentary	OH oval head	RC resistance-capacitance	TERM terminal
MOS metal-oxide semiconductor	OP AMPL operational amplifier	RECT rectifier	TFT thin-film transistor
ms millisecond	OPT option	REF reference	TGL toggle
MTG mounting	OSC oscillator	REG regulated	THD thread
MTR meter (indicating device)	OX oxide	REPL replaceable	THRU through
mV millivolt	oz ounce	RF radio frequency	TI titanium
mVac millivolt, ac	Ω ohm	RFI radio frequency interference	TOL tolerance
mVdc millivolt, dc	P peak (used in parts list)	RH round head; right hand	TRIM trimmer
mVpk millivolt, peak	PAM pulse-amplitude modulation	RLC resistance-inductance-capacitance	TSTR transistor
mVp-p millivolt, peak-to-peak	PC printed circuit	RMO rack mount only	TTL transistor-transistor logic
mVrms millivolt, rms	PCM pulse-code modulation; pulse-count modulation	rms root-mean-square	TV television
mW milliwatt	PDM pulse-duration modulation	RND round	TVI television interference
MUX multiplex	pF picofarad	ROM read-only memory	TWT traveling wave tube
MY mylar	PH BRZ phosphor bronze	R&P rack and panel	U micro (10^6) (used in parts list)
μ A microampere	PHL Phillips	RWV reverse working voltage	UF microfarad (used in parts list)
μ F microfarad	PIN positive-intrinsic-negative	S scattering parameter	UHF ultrahigh frequency
μ H microhenry	PIV peak inverse voltage	s second (time)	UNREG unregulated
μ mho micromho	pk peak	" second (plane angle)	V volt
μ s microsecond	PL phase lock	S-B slow-blow (fuse) (used in parts list)	VA voltampere
μ V microvolt	PLO phase lock oscillator	SCR silicon controlled rectifier; screw	Vac volts, ac
μ Vac microvolt, ac	PM phase modulation	SE selenium	VAR variable
μ Vdc microvolt, dc	PNP positive-negative-positive	SECT sections	VCO voltage-controlled oscillator
μ Vpk microvolt, peak	P/O part of	SEMICON semiconductor	Vdc volts, dc
μ Vp-p microvolt, peak-to-peak	POLY polystyrene	SHF superhigh frequency	VDCW volts, dc, working (used in parts list)
μ Vrms microvolt, rms	PORC porcelain	SI silicon	V(F) volts, filtered
μ W microwatt	POS positive; position(s) (used in parts list)	SIL silver	VFO variable-frequency oscillator
nA nanoampere	POSN position	SL slide	VHF very-high frequency
NC no connection	POT potentiometer	SNR signal-to-noise ratio	Vpk volts, peak
N/C normally closed	p-p peak-to-peak	SPDT single-pole, double-throw	Vp-p volts, peak-to-peak
NE neon	PP peak-to-peak (used in parts list)	SPG spring	Vrms volts, rms
NEG negative	PPM pulse-position modulation	SR split ring	VSWR voltage standing wave ratio
nF nanofarad	PREAMPL preamplifier	SPST single-pole, single-throw	VTO voltage-tuned oscillator
NI PL nickel plate	PRF pulse-repetition frequency	SSB single sideband	VTVM vacuum-tube voltmeter
N/O normally open	PRR pulse repetition rate	SST stainless steel	V(X) volts, switched
NOM nominal	ps picosecond	STL steel	W watt
NORM normal	PT point	SQ square	W/ with
NPN negative-positive-negative	PTM pulse-time modulation	SWR standing-wave ratio	WIV working inverse voltage
NPO negative-positive zero (zero temperature coefficient)	PWM pulse-width modulation	SYNC synchronize	WW wirewound
NRFR not recommended for field replacement		T timed (slow-blow fuse)	W/O without
NSR not separately replaceable		TA tantalum	YIG yttrium-iron-garnet
ns nanosecond		TC temperature compensating	Z _o characteristic impedance
nW nanowatt			
OBD order by description			

NOTE

All abbreviations in the parts list will be in upper-case.

MULTIPLIERS

Abbreviation	Prefix	Multiple
T	tera	10^{12}
G	giga	10^9
M	mega	10^6
k	kilo	10^3
da	deka	10
d	deci	10^{-1}
c	centi	10^{-2}
m	milli	10^{-3}
μ	micro	10^{-6}
n	nano	10^{-9}
p	pico	10^{-12}
f	femto	10^{-15}
a	atto	10^{-18}

Table 6-2. Replaceable Parts

Reference Designation	HP Part Number	Qty	Description	Mfr Code	Mfr Part Number
A1	00435-60005	1	CAL FACTOR SWITCH ASSY	28480	00435-60005
A1R1	0757-0346	15	RESISTOR 10 OHM 1% .125W F TUBULAR	24546	C4-1/8-T0-10R0-F
A1R2	0757-0346		RESISTOR 10 OHM 1% .125W F TUBULAR	24546	C4-1/8-T0-10R0-F
A1R3	0757-0346		RESISTOR 10 OHM 1% .125W F TUBULAR	24546	C4-1/8-T0-10R0-F
A1R4	0757-0346		RESISTOR 10 OHM 1% .125W F TUBULAR	24546	C4-1/8-T0-10R0-F
A1R5	0757-0346		RESISTOR 10 OHM 1% .125W F TUBULAR	24546	C4-1/8-T0-10R0-F
A1R6	0757-0346		RESISTOR 10 OHM 1% .125W F TUBULAR	24546	C4-1/8-T0-10R0-F
A1R7	0757-0346		RESISTOR 10 OHM 1% .125W F TUBULAR	24546	C4-1/8-T0-10R0-F
A1R8	0757-0346		RESISTOR 10 OHM 1% .125W F TUBULAR	24546	C4-1/8-T0-10R0-F
A1R9	0757-0346		RESISTOR 10 OHM 1% .125W F TUBULAR	24546	C4-1/8-T0-10R0-F
A1R10	0757-0346		RESISTOR 10 OHM 1% .125W F TUBULAR	24546	C4-1/8-T0-10R0-F
A1R11	0757-0346		RESISTOR 10 OHM 1% .125W F TUBULAR	24546	C4-1/8-T0-10R0-F
A1R12	0757-0346		RESISTOR 10 OHM 1% .125W F TUBULAR	24546	C4-1/8-T0-10R0-F
A1R13	0757-0346		RESISTOR 10 OHM 1% .125W F TUBULAR	24546	C4-1/8-T0-10R0-F
A1R14	0757-0346		RESISTOR 10 OHM 1% .125W F TUBULAR	24546	C4-1/8-T0-10R0-F
A1R15	0757-0346		RESISTOR 10 OHM 1% .125W F TUBULAR	24546	C4-1/8-T0-10R0-F
A1S1	3100-3073	1	SWITCH: ROTARY	28480	3100-3073
A2	00435-60009	1	RANGE SWITCH ASSY	28480	00435-60009
A2C1	0180-1704	1	CAPACITOR-FXD; 47UF+-10% 6VDC TA-SOLID	56289	150D476X9006B2
A2C2	0180-1746	1	CAPACITOR-FXD; 15UF+-10% 20VDC TA-SOLID	56289	150D156X9020B2
A2C3	0180-0374	4	CAPACITOR-FXD; 100UF+-10% 20VDC TA-SOLID	56289	150D106X9020B2
A2C4	0180-0374	1	CAPACITOR-FXD; 10UF+-10% 20VDC TA-SOLID	56289	150D106X9020B2
A2C5	0180-0229	2	CAPACITOR-FXD; 33UF+-10% 10VDC TA-SOLID	56289	150D336X9010B2
A2R1	0811-3202	1	RESISTOR 30.615K .1% .025W PWH TUBULAR	14140	1409-1/40-30615R-B
A2R2	0811-3203	1	RESISTOR 968 OHM .1% .025W PWH TUBULAR	14140	1409-1/40-968R-B
A2R3	0311-3204	1	RESISTOR 21.616K .1% .025W PWH TUBULAR	14140	1409-1/40-21616R-B
A2R4	0811-3205	1	RESISTOR 6.836K .1% .025W PWH TUBULAR	14140	1409-1/40-6836R-B
A2R5	0811-3206	1	RESISTOR 2.162K .1% .025W PWH TUBULAR	14140	1409-1/40-2162R-B
A2R6	0757-0279	7	RESISTOR 3.16K 1% .125W F TUBULAR	24546	C4-1/8-T0-3161-F
A2R7	0757-0279	1	RESISTOR 3.16K 1% .125W F TUBULAR	24546	C4-1/8-T0-3161-F
A2R8	0698-7284	2	RESISTOR 100K 2% .125W F TUBULAR	24546	C3-1/8-T0-1003-G
A2R9	0757-0465	1	RESISTOR 100K 1% .125W F TUBULAR	24546	C4-1/8-T0-1003-F
A2R10	0698-7284	1	RESISTOR 100K 2% .125W F TUBULAR	24546	C3-1/8-T0-1003-G
A2R11	0757-0465	1	RESISTOR 100K 1% .125W F TUBULAR	24546	C4-1/8-T0-1003-F
A2R12	0757-0465	1	RESISTOR 100K 1% .125W F TUBULAR	24546	C4-1/8-T0-1003-F
A2R13	0757-0279	1	RESISTOR 3.16K 1% .125W F TUBULAR	24546	C4-1/8-T0-3161-F
A2R14	0757-0280	5	RESISTOR 1K 1% .125W F TUBULAR	24546	C4-1/8-T0-1001-F
A2S1	3100-3090	1	SWITCH: ROTARY	28480	3100-3090
A2W1	00435-60014	1	CABLE ASSY, GREEN	28480	00435-60014
A2W2	00435-60015	1	CABLE ASSY, BLUE	28480	00435-60015
A3	00435-60003	1	POWER REFERENCE ASSY	28480	00435-60003
A3C1	0160-3964	2	CAPACITOR-FXD .002UF+-100-0% 300WVDC	28480	0160-3964
A3C2	0160-3964	1	CAPACITOR-FXD .002UF+-100-0% 300WVDC	28480	0160-3964
A3C3	0160-3879	3	CAPACITOR-FXD .01UF+-20% 100WVDC	28480	0160-3879
A3C4	0160-2207	1	CAPACITOR-FXD 300PF+-5% 300WVDC	28480	0160-2207
A3C5	0160-2204	2	CAPACITOR-FXD 100PF+-5% 300WVDC	28480	0160-2204
A3C6	0180-0100	1	CAPACITOR-FXD; 4.7UF+-10% 35VDC TA	56289	150D475X9035B2
A3C7	0160-2251	1	CAPACITOR-FXD 5.6PF+-25PF 500WVDC	28480	0160-2251
A3C8	0160-3878	1	CAPACITOR-FXD .001UF+-20% 100WVDC	28480	0160-3878
A3C9	0160-2150	1	CAPACITOR-FXD 33PF+-5% 300WVDC	28480	0160-2150
A3C10	0160-4006	1	CAPACITOR-FXD 36PF+-5% 300WVDC	28480	0160-4006
A3C11	0160-4007	1	CAPACITOR-FXD 200PF+-5% 300WVDC	28480	0160-4007
A3C12	0160-3879	1	CAPACITOR-FXD .01UF+-20% 100WVDC	28480	0160-3879
A3CR1	1901-0518	4	DIODE-SCHOTTKY	28480	1901-0518
A3CR2	1901-0518		DIODE-SCHOTTKY	28480	1901-0518
A3CR3	0122-0255		DIODE-VVC; SI 1N5144	04713	1N5144
A3J1	1250-1220	1	CONNECTOR-COAX; SMC; 50 OHM MALE	98291	50-C51-0109
A3L1	9140-0144	1	COIL; FXD; MOLDED RF CHOKE; 4.7UH 10%	24226	10/471
A3L2	9100-2232	1	COIL; FXD; MOLDED RF CHOKE; .56UH 10%	24226	15/560
A3L3	00435-80001	1	INDUCTOR; 33 UH	28480	00435-80001
A3PP1	00435-00010	1	SHIELD; CAN	28480	00435-00010
A3Q1	1854-0247	1	TRANSISTOR NPN SI T0-39 PD=1W FT=800MHZ	28480	1854-0247
A3R1	0757-0420	1	RESISTOR 750 OHM 1% .125W F TUBULAR	24546	C4-1/8-T0-751-F
A3R2	0811-3234	1	RESISTOR 10K 1% .05W PWH TUBULAR	20940	140-1/20-1002-F
A3R3	2100-3154	1	RESISTOR; VAR; TRMR; 1KOHM 10% C	32997	3006P-1-102
A3R4	0811-3235	1	RESISTOR 7.5K 1% .05W PWH TUBULAR	20940	140-1/20-7501-F
A3R5	0692-3155	2	RESISTOR 4.6K 1% .125W F TUBULAR	16299	C4-1/8-T0-4641-F

See introduction to this section for ordering information

Table 6-2. Replaceable Parts

Reference Designation	HP Part Number	Qty	Description	Mfr Code	Mfr Part Number
A3R 6	0757-0465		RESISTOR 100K 1% .125W F TUBULAR	24546	C4-1/8-T0-1003-F
A3R7	0757-0465		RESISTOR 100K 1% .125W F TUBULAR	24546	C4-1/8-T0-1003-F
A3R8	0757-0280		RESISTOR 1K 1% .125W F TUBULAR	24546	C4-1/8-T0-1001-F
A3R9	0757-0280		RESISTOR 1K 1% .125W F TUBULAR	24546	C4-1/8-T0-1001-F
A3R10	0757-0442	10	RESISTOR 10K 1% .125W F TUBULAR	24546	C4-1/8-T0-1002-F
A3R11	0698-0083	2	RESISTOR 1.96K 1% .125W F TUBULAR	16299	C4-1/8-T0-1961-F
A3R12	0757-0398	1	RESISTOR 75 OHM 1% .125W F TUBULAR	24346	C4-1/8-T0-750-F
A3R13	0698-3445	1	RESISTOR 348 OHM 1% .125W F TUBULAR	16299	C4-1/8-T0-348R-F
A3R14	0698-3566	1	RESISTOR 53 OHM 1% .125W F TUBULAR	03888	PME55-1/8-T0-53R0-F
A3R15*	0757-0465	10	RESISTOR 100K 1% .125W F TUBULAR * FACTORY SELECTED PART	24546	C4-1/8-T0-1003-F
A3R16*	0757-0465		RESISTOR 100K 1% .125W F TUBULAR * FACTORY SELECTED PART	24546	C4-1/8-T0-1003-F
A3TP1	0360-1514	48	TERMINAL; SLDR STUD	28480	0360-1514
A3TP2	0360-1514		TERMINAL; SLDR STUD	28480	0360-1514
A3U1	1826-0013	6	IC; LIN; OPERATIONAL AMPLIFIER	28480	1826-0013
A3U2	1820-0223	2	IC; LIN; OPERATIONAL AMPLIFIER	27014	LM301AH
A3VR1	1902-0033	1	DIODE; ZENER; 6.2V VZ; .25W MAX PD	03877	1N823
A4	0Q435-60001	1	AMPLIFIER/POWER SUPPLY ASSY	28480	00435-60001
A4C1	0180-2206	2	CAPACITOR-FXD; 60UF+-10% 6VDC TA-SOLID	56289	150D606X9006B2
A4C2	0180-0228	3	CAPACITOR-FXD; 22UF+-10% 15VDC TA-SOLID	56289	150D226X9015B2
A4C3	0160-2055	1	CAPACITOR-FXD .01UF+-10% 100WVDC	28480	0160-2055
A4C4	0160-0164	2	CAPACITOR-FXD .039UF+-10% 200WVDC	56289	292P39392
A4C5	0160-0160	2	CAPACITOR-FXD .0082UF+-10% 200WVDC	56289	292P82292
A4C6	0180-0229		CAPACITOR-FXD; 33UF+-10% 10VDC TA-SOLID	56289	150D336X9010B2
A4C7	0170-0040	2	CAPACITOR-FXD .047UF+-10% 200WVDC	56289	292P47392
A4C8	0160-0164		CAPACITOR-FXD .039UF+-10% 200WVDC	56289	292P39392
A4C9	0180-0197	4	CAPACITOR-FXD; 2.2UF+-10% 20VDC TA	56289	150D225X9020A2
A4C10	0180-0197		CAPACITOR-FXD; 2.2UF+-10% 20VDC TA	56289	150D225X9020A2
A4C11	0160-0161	1	CAPACITOR-FXD .01UF+-10% 200WVDC	56289	292P10392
A4C12	0180-0116	4	CAPACITOR-FXD; 6.8UF+-10% 35VDC TA	56289	150D685X9035B2
A4C13	0180-0116		CAPACITOR-FXD; 6.8UF+-10% 35VDC TA	56289	150D685X9035B2
A4C14	0160-0160		CAPACITOR-FXD .0082UF+-10% 200WVDC	56289	292P82292
A4C15	0170-0040		CAPACITOR-FXD .047UF+-10% 200WVDC	56289	292P47392
A4C16	0180-0374		CAPACITOR-FXD; 10UF+-10% 20VDC TA-SOLID	56289	150D106X9020B2
A4C17	0180-0197		CAPACITOR-FXD; 2.2UF+-10% 20VDC TA	56289	150D225X9020A2
A4C18	0180-0373	1	CAPACITOR-FXD; 6.8UF+-10% 35VDC TA	56289	150D684X9035A2
A4C19	0180-0116		CAPACITOR-FXD; 6.8UF+-10% 35VDC TA	56289	150D685X9035B2
A4C20	0180-0116		CAPACITOR-FXD; 6.8UF+-10% 35VDC TA	56289	150D685X9035B2
A4C21	0160-3456	1	CAPACITOR-FXD .001UF+-10% 1000WVDC	28480	0160-3456
A4C22	0180-1997	1	CAPACITOR-FXD; 20UF+50-10% 150VDC AL	28480	0180-1997
A4C23	0180-0197		CAPACITOR-FXD; 2.2UF+-10% 20VDC TA	56289	150D225X9020A2
A4C24	0180-0374		CAPACITOR-FXD; 10UF+-10% 20VDC TA-SOLID	56289	150D106X9020B2
A4C25	0160-2290	1	CAPACITOR-FXD .15UF+-10% 80WVDC	56289	292P1549R8
A4C26	0160-2204		CAPACITOR-FXD 100PF+-5% 300WVDC	28480	0160-2204
A4C27	0160-3879		CAPACITOR-FXD .01UF+-20% 100WVDC	28480	0160-3879
A4C28	0180-0228		CAPACITOR-FXD; 22UF+-10% 15VDC TA-SOLID	56289	150D226X9015B2
A4C29	0180-0228		CAPACITOR-FXD; 22UF+-10% 15VDC TA-SOLID	56289	150D226X9015B2
A4C30	0180-2206		CAPACITOR-FXD; 60UF+-10% 6VDC TA-SOLID	56289	150D606X9006B2
A4CR1	1901-0518		DIODE-SCHOTTKY	28480	1901-0518
A4CR2	1901-0518		DIODE-SCHOTTKY	28480	1901-0518
A4CR3	1901-0033	5	DIODE-GEN PRP 180V 200MA	28480	1901-0033
A4CR4	1901-0033		DIODE-GEN PRP 180V 200MA	28480	1901-0033
A4CR5	1901-0364	1	DIODE; MULT; FULL WAVE BRIDGE RECTIFIER	04713	SDA 10185-4
A4CR6	1901-0033		DIODE-GEN PRP 180V 200MA	28480	1901-0033
A4CR7	1901-0033		DIODE-GEN PRP 180V 200MA	28480	1901-0033
A4CR8	1902-0184	1	DIODE-ZNR 16.2V 5% DO-7 PD=.4W	28480	1902-0184
A4CR9	1901-0033		DIODE-GEN PRP 180V 200MA	28480	1901-0033
A4J1	0360-1514		TERMINAL; SLDR STUD	28480	0360-1514
A4J2	0360-1514		TERMINAL; SLDR STUD	28480	0360-1514
A4K1	0490-0916	1	RELAY; REED; 1A .5A 50V CONT; 5V COIL	28480	0490-0916
A4MP1	1205-0085	2	HEAT-DISSIPATOR; SGL; TO-49 PKG	28480	1205-0085
A4MP2	1205-0085		HEAT-DISSIPATOR; SGL; TO-49 PKG	28480	1205-0085
A4P1	0362-0063	11	TERMINAL, CRP, QD ISC FEM, 0.046 TAB,	91886	122-0192-019
A4P2	0362-0063		TERMINAL, CRP, QD ISC FEM, 0.046 TA3,	91886	122-0192-019
A4Q1	1853-0020	3	TRANSISTOR PNP SI CHIP PD=300MW	28480	1853-0020
A4Q2	1853-0020		TRANSISTOR PNP SI CHIP PD=300MW	28480	1853-0020
A4Q3	1854-0071	5	TRANSISTOR NPN SI PD=300MW FT=200MHZ	28480	1854-0071
A4Q4	1854-0071		TRANSISTOR NPN SI PD=300MW FT=200MHZ	28480	1854-0071
A4Q5	1854-0071		TRANSISTOR NPN SI PD=300MW FT=200MHZ	28480	1854-0071

See introduction to this section for ordering information

Table 6-2. Replaceable Parts

Reference Designation	HP Part Number	Qty	Description	Mfr Code	Mfr Part Number
A4C6	1855-0020	2	TRANSISTOR; J-FET N-CHAN, D-MODE SI	28480	1855-0020
A4C7	1855-0020		TRANSISTOR; J-FET N-CHAN, D-MODE SI	28480	1855-0020
A4Q8	1853-0001	1	TRANSISTOR PNP SI CHIP TO-39 PD=600MW	28480	1853-0001
A4Q9	1854-0003	1	TRANSISTOR NPN SI TO-39 PD=800MW	28480	1854-0003
A4Q10	1853-0012	2	TRANSISTOR PNP 2N2904A SI CHIP	01295	2N2904A
A4C11	1853-0012		TRANSISTOR PNP 2N2904A SI CHIP	01295	2N2904A
A4Q12	1854-0072	1	TRANSISTOR NPN 2N3054 SI PD=25W	02735	2N3054
A4Q13	1853-0052	1	TRANSISTOR PNP 2N3740 SI CHIP PD=25W	04713	2N3740
A4C14	1854-0071		TRANSISTOR NPN SI PD=300MW FT=200MHZ	28480	1854-0071
A4C15	1854-0071		TRANSISTOR NPN SI PD=300MW FT=200MHZ	28480	1854-0071
A4C16	1854-0090	1	TRANSISTOR NPN SI TO-39 PD=1W FT=100MHZ	28480	1854-0090
A4Q17	1853-0038	1	TRANSISTOR PNP SI CHIP TO-39 PD=1W	28480	1853-0038
A4C18	1853-0020		TRANSISTOR PNP SI CHIP PD=300MW	28480	1853-0020
A4R1	0698-3160	3	RESISTOR 31.6K 1% .125W F TUBULAR	16299	C4-1/8-T0-3162-F
A4R2	0698-3156	1	RESISTOR 14.7K 1% .125W F TUBULAR	16299	C4-1/8-T0-1472-F
A4R3	0757-0288	1	RESISTOR 9.09K 1% .125W F TUBULAR	30983	MF4C1/8-T0-9091-F
A4R4	0698-3150	2	RESISTOR 2.37K 1% .125W F TUBULAR	16299	C4-1/8-T0-2371-F
A4R5	0698-3152	1	RESISTOR 3.48K 1% .125W F TUBULAR	16299	C4-1/8-T0-3481-F
A4R6	0757-0459	2	RESISTOR 56.2K 1% .125W F TUBULAR	24546	C4-1/8-T0-5622-F
A4R7	0757-0465		RESISTOR 100K 1% .125W F TUBULAR	24546	C4-1/8-T0-1003-F
A4R8	0757-0444	1	RESISTOR 12.1K 1% .125W F TUBULAR	24546	C4-1/8-T0-1212-F
A4R9	0757-0442		RESISTOR 10K 1% .125W F TUBULAR	24546	C4-1/8-T0-1002-F
A4R10	0698-3159	3	RESISTOR 26.1K 1% .125W F TUBULAR	16299	C4-1/8-T0-2612-F
A4R11	0698-3159		RESISTOR 26.1K 1% .125W F TUBULAR	16299	C4-1/8-T0-2612-F
A4R12	0757-0279		RESISTOR 3.16K 1% .125W F TUBULAR	24546	C4-1/8-T0-3161-F
A4R13	0757-0442		RESISTOR 10K 1% .125W F TUBULAR	24546	C4-1/8-T0-1002-F
A4R14	0698-3446	1	RESISTOR 383 OHM 1% .125W F TUBULAR	16299	C4-1/8-T0-383R-F
A4R15	0757-0462	2	RESISTOR 75K 1% .125W F TUBULAR	24546	C4-1/8-T0-7502-F
A4R16	0757-0279		RESISTOR 3.16K 1% .125W F TUBULAR	24546	C4-1/8-T0-3161-F
A4R17	0757-0462		RESISTOR 75K 1% .125W F TUBULAR	24546	C4-1/8-T0-7502-F
A4R18	0757-0442		RESISTOR 10K 1% .125W F TUBULAR	24546	C4-1/8-T0-1002-F
A4R19	0811-3214	1	RESISTOR 31.62 OHM .1% .025W PWM	14140	1409-1/40-31R62-B
A4R20	0811-3218	1	RESISTOR 1K .1% .0125W PWM TUBULAR	14140	1409-1/80-1001-B
A4R21	0757-0290	1	RESISTOR 6.19K 1% .125W F TUBULAR	30983	MF4C1/8-T0-6191-F
A4R22	0698-3450	2	RESISTOR 42.2K 1% .125W F TUBULAR	16299	C4-1/8-T0-4222-F
A4R23	0757-0278	2	RESISTOR 1.78K 1% .125W F TUBULAR	24546	C4-1/8-T0-1781-F
A4R24	0757-0438	1	RESISTOR 5.11K 1% .125W F TUBULAR	24546	C4-1/8-T0-5111-F
A4R25	0698-3162	2	RESISTOR 46.4K 1% .125W F TUBULAR	16299	C4-1/8-T0-4642-F
A4R26	0757-0280		RESISTOR 1K 1% .125W F TUBULAR	24546	C4-1/8-T0-1001-F
A4R27	0698-3450		RESISTOR 42.2K 1% .125W F TUBULAR	16299	C4-1/8-T0-4222-F
A4R28	0757-0278		RESISTOR 1.78K 1% .125W F TUBULAR	24546	C4-1/8-T0-1781-F
A4R29	0757-0442		RESISTOR 10K 1% .125W F TUBULAR	24546	C4-1/8-T0-1002-F
A4R30	0757-0442		RESISTOR 10K 1% .125W F TUBULAR	24546	C4-1/8-T0-1002-F
A4R31	0698-3158	2	RESISTOR 23.7K 1% .125W F TUBULAR	16299	C4-1/8-T0-2372-F
A4R32	2100-1738	2	RESISTOR; VAR; TRMR; 10KOHM 10% C	19701	ET50W103
A4R33	0698-8300	1	RESISTOR 840 OHM 1% .125W F TUBULAR	30983	MF4C1/8-T0-840R-F
A4R34	0757-0280		RESISTOR 1K 1% .125W F TUBULAR	24546	C4-1/8-T0-1001-F
A4R35	2100-2061	1	RESISTOR; VAR; TRMR; 200 OHM 10% C	30983	ET50W201
A4R36	0757-0419	1	RESISTOR 681 OHM 1% .125W F TUBULAR	24546	C4-1/8-T0-681R-F
A4R37	0757-0399	1	RESISTOR 82.5 OHM 1% .125W F TUBULAR	24546	C4-1/8-T0-8251-F
A4R38	0698-3154	1	RESISTOR 4.22K 1% .125W F TUBULAR	16299	C4-1/8-T0-4221-F
A4R39	0698-3150		RESISTOR 2.37K 1% .125W F TUBULAR	16299	C4-1/8-T0-2371-F
A4R40			NOT ASSIGNED		
A4R41			NOT ASSIGNED		
A4R42	2100-1738		RESISTOR; VAR; TRMR; 10KOHM 10% C	19701	ET50W103
A4R43	0683-2265	1	RESISTOR 22M 5% .25W CC TUBULAR	01121	CB2265
A4R44	0698-3160		RESISTOR 31.6K 1% .125W F TUBULAR	16299	C4-1/8-T0-3162-F
A4R45	0757-0467	1	RESISTOR 121K 1% .125W F TUBULAR	24546	C4-1/8-T0-1213-F
A4R46	2100-2031	1	RESISTOR; VAR; TRMR; 50KOHM 10% C	30983	ET50W503
A4R47	0757-0841	1	RESISTOR 12.1K 1% .5W F TUBULAR	30983	MF7C1/2-T0-1212-F
A4R48	0757-1000	1	RESISTOR 51.1 OHM 1% .5W F TUBULAR	30983	MF7C1/2-T0-51R1-F
A4R49	0683-0685	1	RESISTOR 6.8 OHM 5% .25W CC TUBULAR	01121	CB68G5
A4R50	0757-0465		RESISTOR 100K 1% .125W F TUBULAR	24546	C4-1/8-T0-1003-F
A4R51	0757-0465		RESISTOR 100K 1% .125W F TUBULAR	24546	C4-1/8-T0-1003-F
A4R52	0698-3157	1	RESISTOR 19.6K 1% .125W F TUBULAR	16299	C4-1/8-T0-1962-F
A4R53	0757-0279		RESISTOR 3.16K 1% .125W F TUBULAR	24546	C4-1/8-T0-3161-F
A4R54	0698-3159		RESISTOR 26.1K 1% .125W F TUBULAR	16299	C4-1/8-T0-2612-F
A4R55	0683-1555	1	RESISTOR 1.5M 5% .25W CC TUBULAR	01121	CB1555
A4R56	0757-0442		RESISTOR 10K 1% .125W F TUBULAR	24546	C4-1/8-T0-1002-F
A4R57	0757-0441	1	RESISTOR 8.25K 1% .125W F TUBULAR	24546	C4-1/8-T0-8251-F
A4R58	0757-0428	1	RESISTOR 1.62K 1% .125W F TUBULAR	24546	C4-1/8-T0-1621-F
A4R59	0698-3155		RESISTOR 4.64K 1% .125W F TUBULAR	16299	C4-1/8-T0-4641-F
A4R60	0698-3162		RESISTOR 46.4K 1% .125W F TUBULAR	16299	C4-1/8-T0-4642-F
A4R61	0757-1094	1	RESISTOR 1.47K 1% .125W F TUBULAR	24546	C4-1/8-T0-1471-F
A4R62	0698-3449	1	RESISTOR 28.7K 1% .125W F TUBULAR	16299	C4-1/8-T0-2872-F
A4R63	0757-0442		RESISTOR 10K 1% .125W F TUBULAR	24546	C4-1/8-T0-1002-F
A4R64	0757-0442		RESISTOR 10K 1% .125W F TUBULAR	24546	C4-1/8-T0-1002-F
A4R65	0757-0403	1	RESISTOR 121 OHM 1% .125W F TUBULAR	24546	C4-1/8-T0-121R-F

See introduction to this section for ordering information

Table 6-2. Replaceable Parts

Reference Designation	HP Part Number	Qty	Description	Mfr Code	Mfr Part Number
A4R66	0698-3453	1	RESISTOR 196K 1% .125W F TUBULAR * FACTORY SELECTED PART	16299	C4-1/8-T0-1963-F
A4R67	0698-0084	1	RESISTOR 2.15K 1% .125W F TUBULAR	16299	C4-1/8-T0-2151-F
A4R68	0698-0083	1	RESISTOR 1.96K 1% .125W F TUBULAR	16299	C4-1/8-T0-1961-F
A4R69	0683-3355	1	RESISTOR 3.3M 5% .25W CC TUBULAR	01121	C83355
A4R70	0757-0279	1	RESISTOR 3.16K 1% .125W F TUBULAR	24546	C4-1/8-T0-3161-F
A4R71	0757-0442	1	RESISTOR 10K 1% .125W F TUBULAR	24546	C4-1/8-T0-1002-F
A4R72	0698-3160	1	RESISTOR 31.6K 1% .125W F TUBULAR	16299	C4-1/8-T0-3162-F
A4R73	0757-0274	1	RESISTOR 1.21K 1% .125W F TUBULAR	24546	C4-1/8-T0-1213-F
A4R74	0698-3440	1	RESISTOR 196 OHM 1% .125W F TUBULAR	16299	C4-1/8-T0-196R-F
A4R75	0698-3158	1	RESISTOR 23.7K 1% .125W F TUBULAR	16299	C4-1/8-T0-2372-F
A4RT1	0839-0011	1	THERMISTOR, NEG TC, 100 OHM DISC	83186	21E23
A4TP1	0360-1514	1	TERMINAL; SLDR STUD	28480	0360-1514
A4TP2	0360-1514	1	TERMINAL; SLDR STUD	28480	0360-1514
A4TP3	0360-1514	1	TERMINAL; SLDR STUD	28480	0360-1514
A4TP4	0360-1514	1	TERMINAL; SLDR STUD	28480	0360-1514
A4TP5	0360-1514	1	TERMINAL; SLDR STUD	28480	0360-1514
A4TP6	0360-1514	1	TERMINAL; SLDR STUD	28480	0360-1514
A4TP7	0360-1514	1	TERMINAL; SLDR STUD	28480	0360-1514
A4TP8	0360-1514	1	TERMINAL; SLDR STUD	28480	0360-1514
A4TP9	0360-1514	1	TERMINAL; SLDR STUD	28480	0360-1514
A4TP10	0360-1514	1	TERMINAL; SLDR STUD	28480	0360-1514
A4TP11	0360-1514	1	TERMINAL; SLDR STUD	28480	0360-1514
A4TP12	0360-1514	1	TERMINAL; SLDR STUD	28480	0360-1514
A4U1	1826-0013	1	IC; LIN; OPERATIONAL AMPLIFIER	28480	1826-0013
A4U2	1826-0013	1	IC; LIN; OPERATIONAL AMPLIFIER	28480	1826-0013
A4U3	1826-0013	1	IC; LIN; OPERATIONAL AMPLIFIER	28480	1826-0013
A4U4	1826-0092	1	IC; LIN; OPERATIONAL AMPLIFIER	04713	MC7812CP
A4U5	1826-0013	1	IC; LIN; OPERATIONAL AMPLIFIER	28480	1826-0013
A4U6	1826-0013	1	IC; LIN; OPERATIONAL AMPLIFIER	28480	1826-0013
A4U7	1820-0223	1	IC; LIN; OPERATIONAL AMPLIFIER	27014	LM301AH
A4VR1, VR2	1902-3002	2	DIODE-ZNR 2.37V 5% DO-7 PD=.4W TC=	04713	SZ 10939-2
A4VR3	1902-0041	1	DIODE-ZNR 5.11V 5% DO-7 PD=.4W TC=	04713	SZ 10939-98
A4VR4	1902-3182	1	DIODE-ZNR 12.1V 5% DO-7 PD=.4W	04713	SZ 10939-206
A4W1	00435-60013	1	CABLE, GRAY SHIELDED, 2-CONDUCTOR	28480	00435-60013
A4A1	00435-60010	1	AUTO ZERO ASSY	28480	00435-60010
A4A1C1		1	NSR, P/O A4A1 ASSY		
A4A1C2		1	NSR, P/O A4A1 ASSY		
A4A1C3		1	NSR, P/O A4A1 ASSY		
A4A1C4		1	NSR, P/O A4A1 ASSY		
A4A1CR1		1	NSR, P/O A4A1 ASSY		
A4A1K1		1	NSR, P/O A4A1 ASSY		
A4A1Q1		1	NSR, P/O A4A1 ASSY		
A4A1R1		1	NSR, P/O A4A1 ASSY		
A4A1R2		1	NSR, P/O A4A1 ASSY		
A4A1R3		1	NSR, P/O A4A1 ASSY		
A4A1R4		1	NSR, P/O A4A1 ASSY		
A5	5060-9409	1	POWER MODULE ASSY, JADE GRAY	28480	5060-9409
A5J1	0360-1514	1	TERMINAL; SLDR STUD	28480	0360-1514
A5J2	0360-1514	1	TERMINAL; SLDR STUD	28480	0360-1514
A5J3	0360-1514	1	TERMINAL; SLDR STUD	28480	0360-1514
A5J4	0360-1514	1	TERMINAL; SLDR STUD	28480	0360-1514
A5J5	0360-1514	1	TERMINAL; SLDR STUD	28480	0360-1514
A5J6	0360-1514	1	TERMINAL; SLDR STUD	28480	0360-1514
A5J7	0360-1514	1	TERMINAL; SLDR STUD	28480	0360-1514
A5J8	0360-1514	1	TERMINAL; SLDR STUD	28480	0360-1514
A5J9	0360-1514	1	TERMINAL; SLDR STUD	28480	0360-1514
A5J10		1	NSR, PART OF A5 ASSY		
CHASSIS PARTS					
B11	1420-0096	1	BATTERY: 28.8V (FOR OPT 001)	28480	1420-0096
D51	2140-0244	1	LAMP, GLOW, BULB T-2, 105V (PART OF S1)	87034	A1H
F1	2110-0004	1	FUSE .25A 250V (FOR 100,120 VAC OPERATION)	71400	AGC-1/4
F1	2110-0027	1	FUSE .125A 250V (FOR 220,240 VAC OPERATION)	71400	AGC 1/8

See introduction to this section for ordering information

Table 6-3. Replaceable Parts

Reference Designation	HP Part Number	Qty	Description	Mfr Code	Mfr Part Number
J1	1251-3228	2	CONNECTOR, 12-CONTR, FEM, CIRC AUDIO (P/O W1, SEE MP4)	13511	91T3638-1000
J2			NSR P/O W3 OR W9; SEE MP3 AND MP6.		
J3	1250-0118	2	CONNECTOR-COAX; GNC; 50 OHM FEMALE	90949	31-2221-1022
J4	1250-0118		CONNECTOR-COAX; GNC; 50 OHM FEMALE	90949	31-2221-1022
J5	1251-3228		CONNECTOR, 12-CONTR, FEM, CIRC AUDIO (P/O W6, SEE MP4)	13511	91T3638-1000
M1	1120-1513	1	METER	28480	1120-1513
MF1	0370-1100	1	KNOB; BASE-CONC PTR, .5 IN, JGK (CAL FACTOR SWITCH)	28480	0370-1100
MP2	0370-2388	1	KNOB; BAR SKIRTED, JADE GRAY (RANGE SWITCH)	28480	0370-2388
MP3	0590-0011	1	NUT; KNRLD R 5/8-24 .125 X .75; BRS; NI (USED WITH J2)	28480	0590-0011
MP4	1251-3362	1	NUT; HEX (USED WITH J1 AND J5)	28480	1251-3362
MF5	0590-0923	1	NUT; KNRLD R 1/2-32 .125 X .435; SST; (P/O S1)	28480	0590-0923
MP6	2950-0079	1	NUT; HEX 5/8-24 .125 X .75; BRS (P/O W0 OR W9, (USED WITH J2)	76854	169597-002

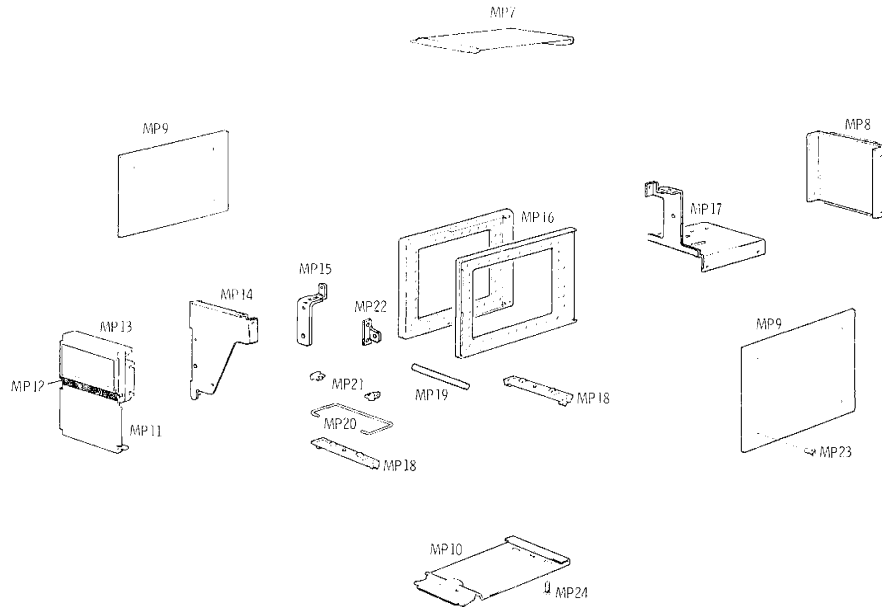

Figure 6-1. Cabinet Parts, Exploded View

MP7	5060-8555	1	COVER ASSY:TOP 5 X 11	28480	5060-8555
MP8	00435-00003	1	PANEL, REAR	28480	00435-00003
MP9	5000-8565	2	COVER:SIDE	28480	5000-8565
MP10	5000-8571	1	COVER:BOTTOM 5 X 11	28480	5000-8571
MF11	00435-00001	1	PANEL, FRONT	28480	00435-00001
MP12	00435-00011	1	GUSSET, FRONT PANEL	28480	00435-00011
MP13	5020-7633	1	METER TRIM:THIRD MODULE	28480	5020-7633
MF14	00435-00004	1	BRACKET, SWITCH	28480	00435-00004
MP15	00435-00005	1	BRACKET MOUNTING, MICROSWITCH	28480	00435-00005
MP16	5060-0703	2	FRAME ASSY:6 X 11 SM	28480	5060-0703
MP17	00435-00007	1	DECK, CHASSIS	28480	00435-00007
MF18	5060-0727	2	FOOT ASSY	28480	5060-0727
MF19	5020-0700	1	SPACER:CABINET	28480	5020-0700
MP20	1490-0031	1	SPRING WFRM .156-OD SST	28480	1490-0031
MP21	5040-0700	2	HINGE	28480	5040-0700
MF22	00435-00002	1	BRACKET MOUNTING, CAL POT	28480	00435-00002
MF23	2360-0190	8	SCREW-MACH 6-32 100 DEG FL HD POZI REC	28480	2360-0190
MF24	2360-0194	2	SCREW-MACH 6-32 100 DEG FL HD POZI REC	28480	2360-0194

See introduction to this section for ordering information

Table 6-2. Replaceable Parts

Reference Designation	HP Part Number	Qty	Description	Mfr Code	Mfr Part Number
P1	0362-0063		TERMINAL, CRP, QDISC FEM, 0.046 TAB,	91886	122-0192-019
P2	0362-0063		TERMINAL, CRP, QDISC FEM, 0.046 TAB,	91886	122-0192-019
P3	0362-0063		TERMINAL, CRP, QDISC FEM, 0.046 TAB,	91886	122-0192-019
P4	0362-0063		TERMINAL, CRP, QDISC FEM, 0.046 TAB,	91886	122-0192-019
P5	0362-0063		TERMINAL, CRP, QDISC FEM, 0.046 TAB,	91886	122-0192-019
P6	0362-0063		TERMINAL, CRP, QDISC FEM, 0.046 TAB,	91886	122-0192-019
P7	0362-0063		TERMINAL, CRP, QDISC FEM, 0.046 TAB,	91886	122-0192-019
P8	0362-0063		TERMINAL, CRP, QDISC FEM, 0.046 TAB,	91886	122-0192-019
P9	0362-0063		TERMINAL, CRP, QDISC FEM, 0.046 TAB,	91886	122-0192-019
P10	1250-1411	1	CONNECTOR-COAX; SMC; 50 OHM FEMALE (P/O W3 OR W9)	98291	50-328-3188
R1	2100-3342	1	R:VAR 10K OHM 5% 10-TURN	28480	2100-3342
R2	0757-0459		RESISTOR 56.2K 1% .125W F TUBULAR (P/O W2)	24546	C4-1/8-T0-5622-F
S1	3101-1395	1	SWITCH; PB 1-STA RECT DPDT (P/O W2, INCLUDES DS1 AND MP5)	87034	53-67280-121/A1H
S2	3102-0006	1	SWITCH-SENS SPDT SUBMIN .5A 28VDC (ZERO)	28480	3102-0006
	00435-00006	1	SPRING, PUSHBUTTON	28480	00435-00006
	00435-40001	1	PUSHBUTTON, MICROSWITCH	28480	00435-40001
	03603-2004	1	NUT PLATE, MICROSWITCH	28480	03603-2004
S3	3101-0070	1	SWITCH; SL; DPDT NS; .5A 125VAC/DC (POWER REF. SWITCH)	79727	6F-126-0000
T1	9100-3391	1	TRANSFORMER	28480	9100-3391
TB1	5020-8122	1	LINE VOLTAGE SELECTION CARD	28480	5020-8122
W1	00435-60006	1	CABLE, INPUT, GRAY (INCL J1, SEE MP4, OMITTED ON OPT 003)	28480	00435-60006
W2	00435-60007	1	CABLE, POWER PRIMARY (INCLUDES R2 AND S1)	28480	00435-60007
W3	00435-60004	1	CABLE, POWER REFERENCE (INCLUDES J2, P10 AND MP6, SEE MP3, OMITTED ON OPT 003)	28480	00435-60004
W4	00435-60011	1	CABLE, POWER SENSOR, 5', STANDARD (OMIT ON OPT 009,010,011,012 & 013)	28480	00435-60011
	00435-60020	1	CABLE, POWER SENSOR, 10' (OPT 009 ONLY)	28480	00435-60020
	00435-60021	1	CABLE, POWER SENSOR, 20' (OPT 010 ONLY)	28480	00435-60021
	00435-60022	1	CABLE, POWER SENSOR, 50' (OPT 011 ONLY)	28480	00435-60022
	00435-60023	1	CABLE, POWER SENSOR, 100' (OPT 012 ONLY)	28480	00435-60023
	00435-60024	1	CABLE, POWER SENSOR, 200' (OPT 013 ONLY)	28480	00435-60024
W5	8120-1378	1	CABLE; UNSHLD 3-COND 18AWG	28480	8120-1378
W6	00435-60027	1	CABLE, INPUT, GRAY (INCL J5, SEE MP4, FOR OPT 002 & 003)	28480	00435-60027
W7	00435-60025	1	CABLE, GREEN	28480	00435-60025
W8	00435-60026	1	CABLE, BLUE, 2-CONDUCTOR	28480	00435-60026
W9	00435-60028	1	CABLE, POWER REFERENCE (INCL J2, P10 AND MP6), SEE MP3, OPT 003 ONLY).	28480	00435-60028
XA4	1251-0233	1	CONNECTOR; PC EDGE; 22-CONT; SOLDER EYE	71785	251-22-30-261
			MISCELLANEOUS PARTS		
	0403-0131	2	GUIDE, P.C. BOARD, GRAY	28480	0403-0131
	6960-0010	1	PLUG, HOLE, STANDARD HD, .625 DIA STEEL	77122	
	6960-0024	1	PLUG, HOLE, STANDARD HD, .688 DIA NYLON	28520	P-687
	5040-0345	4	INSULATOR-CONNECTOR	28480	5040-0345
	00435-00009	1	CLAMP, BATTERY (OPT 001 ONLY)	28480	00435-00009

See introduction to this section for ordering information

Table 6-3. Code List of Manufacturers

MFR NO.	MANUFACTURER NAME	ADDRESS	ZIP CODE
01121	ALLEN BRADLEY CO	MILWAUKEE WI	53212
01295	TEXAS INSTR INC SEMICOND CMPNT DIV	DALLAS TX	75231
02735	RCA CORP SOLID STATE DIV	SOMMERVILLE NJ	08876
03877	TRANSITRON ELECTRONIC CORP	WAKEFIELD MA	01880
03988	PYPPIFILM CORP	WHIPPANY NJ	07981
04713	MOTOROLA SEMICONDUCTOR PRODUCTS	PHOENIX AZ	85008
14140	EDISON ELEK DIV MCGRAW-EDISON	MANCHESTER NH	03130
16299	CORNING GL WK ELEC CMPNT DIV	RALEIGH NC	27604
19701	MEPCO/ELECTRA CORP	MINERAL WELLS TX	76067
20940	MICRO-DMM CORP	FL MONTE CA	91731
24226	GOWANDA ELECTRONICS CORP	GOWANDA NY	14070
24546	CORNING GLASS WORKS	BRADFORD PA	16701
27014	NATIONAL SEMICONDUCTOR CORP	SANTA CLARA CA	95051
28480	HEWLETT-PACKARD CO CORPORATE HQ	PALO ALTO CA	94304
28520	HEYMAN MFG CO	KENILWORTH NJ	07033
30963	MEPCO/ELECTRA CORP	SAN DIEGO CA	92121
32997	SOURNS INC TRIMPOT PROD DIV	RIVERSIDE CA	92507
56289	SPRAGUE ELECTRIC CO	NORTH ADAMS MA	01247
71400	BUSSMAN MFG DIV OF MCGRAW-EDISON CO	ST LOUIS MO	63017
71785	TRW ELEK COMPONENTS CINCH DIV	ELK GROVE VILLAGE IL	60007
76854	OAK IND INC SW DIV	CRYSTAL LAKE IL	60014
77122	PALNUT CO UNITED-CARR DIV TRW INC	MOUNTAINSIDE NJ	07092
79727	G-H INDUSTRIES	WARMINGSTER PA	18974
83186	VICTORY ENGINEERING CORP	SPRINGFIELD NJ	07081
87034	MARCO-OAK DIV OAK IND INC	ANAHEIM CA	92803
90949	AMPHENOL SALES DIV OF BUNKER-RAMO	HAZELWOOD MO	63042
91886	MALCO MFG CO INC	CHICAGO IL	60650
96291	SEAELECTRO CORP	MAMARONECK NY	10544

SECTION VII MANUAL CHANGES

7-1. INTRODUCTION

7-2. This section contains information for adapting this manual to instruments for which the content does not apply directly. In addition, information about recommended modifications for improvements to the instruments is provided.

7-3. MANUAL CHANGES

7-4. To adapt this manual to your instrument, refer to Table 7-1 and make all of the manual

changes listed opposite your instrument serial number.

7-5. If your instrument serial number is not listed on the title page of this manual or in Table 7-1 below, it may be documented in a yellow MANUAL CHANGES supplement. For additional important information about serial number coverage refer to INSTRUMENTS COVERED BY MANUAL in Section I.

Table 7-1. Manual Changes by Serial Number

Serial Prefix or Number	Make Manual Change
1234A	A

MANUAL CHANGES

7-6. MANUAL CHANGE INSTRUCTIONS

CHANGE A

Table 6-2:

Change:

- A3R14 to 0698-5068, R: FXD 50 OHM 1% 1/8W F TUBULAR, 30983, MF4C1/8-T9-50R0-F.
- A4R67 to 0757-0280, RESISTOR, FXD 1K 1% 1/8W F TUBULAR, 24546, C4-1/8-TO-1001-F.
- A4R68 to 0757-0444, RESISTOR, FXD 12.1K 1% 1/8W F TUBULAR, 24546, C4-1/8-TO-1302-F.
- A4U4 to 1826-0013, INTEGRATED CIRCUIT; LINEAR OP AMP, 28480, 1826-0013.

Delete A3L3, A4C30, A4R74, and A4R75.

Figure 8-7, (Service Sheet 2):

Change the diagram as shown by the partial schematics, Figures 7-1 and 7-2.

Figure 8-11 (Service Sheet 3):

Delete A4R74 (The connection is made directly from A4A1 output to XA4 pin 40).

Figure 8-13 (Service Sheet 4):

Change the diagram as shown by the partial schematic, Figure 7-3.

MANUAL CHANGES

CHANGE A (cont'd)

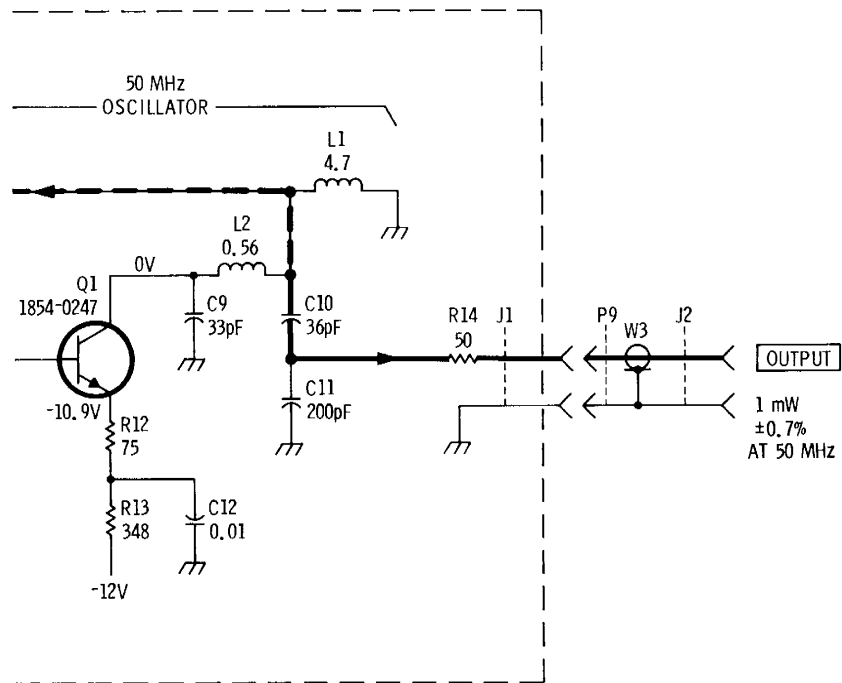

Figure 7-3. P/O A3 Assembly Schematic (Part of Change A)

INSTRUMENT MODIFICATIONS

7-7. MODIFICATION OF A4 ASSEMBLY (SERIAL PREFIX 1234A)

7-8. The Power Meter's A4 assembly must be changed to HP Part Number 00435-60001 Revision B (B-130304) when used with a Power Sensor Cable of length greater than 5-feet. The new board, which may be used without further modification, may be ordered through your nearest Hewlett-Packard office.

NOTE

Perform the adjustments in Section V after installing the new board.

SECTION VIII SERVICE

8-1. INTRODUCTION

8-2. Service information is provided in this section. General service information relates to troubleshooting. Repair information relates to performance testing and adjustments after repairs are made. The service sheets include principles of operation and troubleshooting information, location diagrams, and a schematic diagram.

8-3. The last foldout in the manual includes a table, which cross-references all pictorial and schematic locations of each assembly, and chassis mounted and adjustable component. The foldout also shows the location of each assembly, chassis mounted component, and adjustable component.

8-4. SAFETY CONSIDERATIONS

8-5. Although this instrument has been designed in accordance with international safety standards, this manual contains information, cautions, and warnings which must be followed to ensure safe operation and to retain the instrument in safe condition (see Sections II, III, and V). Service and adjustments should be performed only by qualified service personnel.

WARNING

Any interruption of the protective (grounding) conductor (inside or outside the instrument) or disconnection of the protective earth terminal is likely to make the instrument dangerous. Intentional interruption is prohibited.

8-6. Any adjustment, maintenance, and repair of the opened instrument under voltage should be avoided as much as possible and, when inevitable, should be carried out only by a skilled person who is aware of the hazard involved.

8-7. Capacitors inside the instrument may still be charged even if the instrument has been disconnected from its source of supply.

8-8. Make sure that only fuses with the required rated current and of the specified type (normal blow, time delay, etc.) are used for replacement.

The use of repaired fuses and the short-circuiting of fuseholders must be avoided.

8-9. Whenever it is likely that this protection has been impaired, the instrument must be made inoperative and be secured against any unintended operation.

WARNING

The service information is often used with power supplied and protective covers removed from the instrument. Energy available at many points may, if contacted, result in personal injury.

8-10. SERVICE SHEETS

8-11. The service sheets normally include principles of operation and troubleshooting information, a component location diagram, and a schematic, all of which apply to a specific portion of circuitry within the instrument.

8-12. Service Sheet 1 includes an overview of the instrument operation, troubleshooting on an assembly or stage level, and a troubleshooting block diagram. The block diagram also serves as an "index" for the other service sheets.

8-13. The Schematic Diagram Notes, Figure 8-3, aids in interpreting the schematics.

8-14. Principles of Operation

8-15. The operation of the circuitry shown by the schematic diagram is explained in the Principles of Operation. This information is outlined by using assembly and stage names. These names also separate circuit areas on the schematic diagrams.

8-16. Troubleshooting

8-17. This information is in the form of hints and suggestions pertaining to problems one may encounter while troubleshooting the 435A. The troubleshooting information is located on the left-hand foldout of the service sheet following the Principles of Operation.

8-18. On Service Sheet 1, a malfunction is isolated to an assembly or stage. After turning to the appropriate service sheet, troubleshooting continues on a stage and/or component level.

8-19. DC voltages and in some cases, ac voltages and waveforms are included on the schematics. Test points are physically located on printed circuit boards and have assigned reference designators

and symbols on the schematics. The waveforms and/or voltages refer to the test points and other important circuit junctions.

8-20. A circuit board extender, which provides easy access for troubleshooting, is shown in Figure 8-1. The extender may be ordered through your nearest HP office. Refer to Equipment Available in Section I.

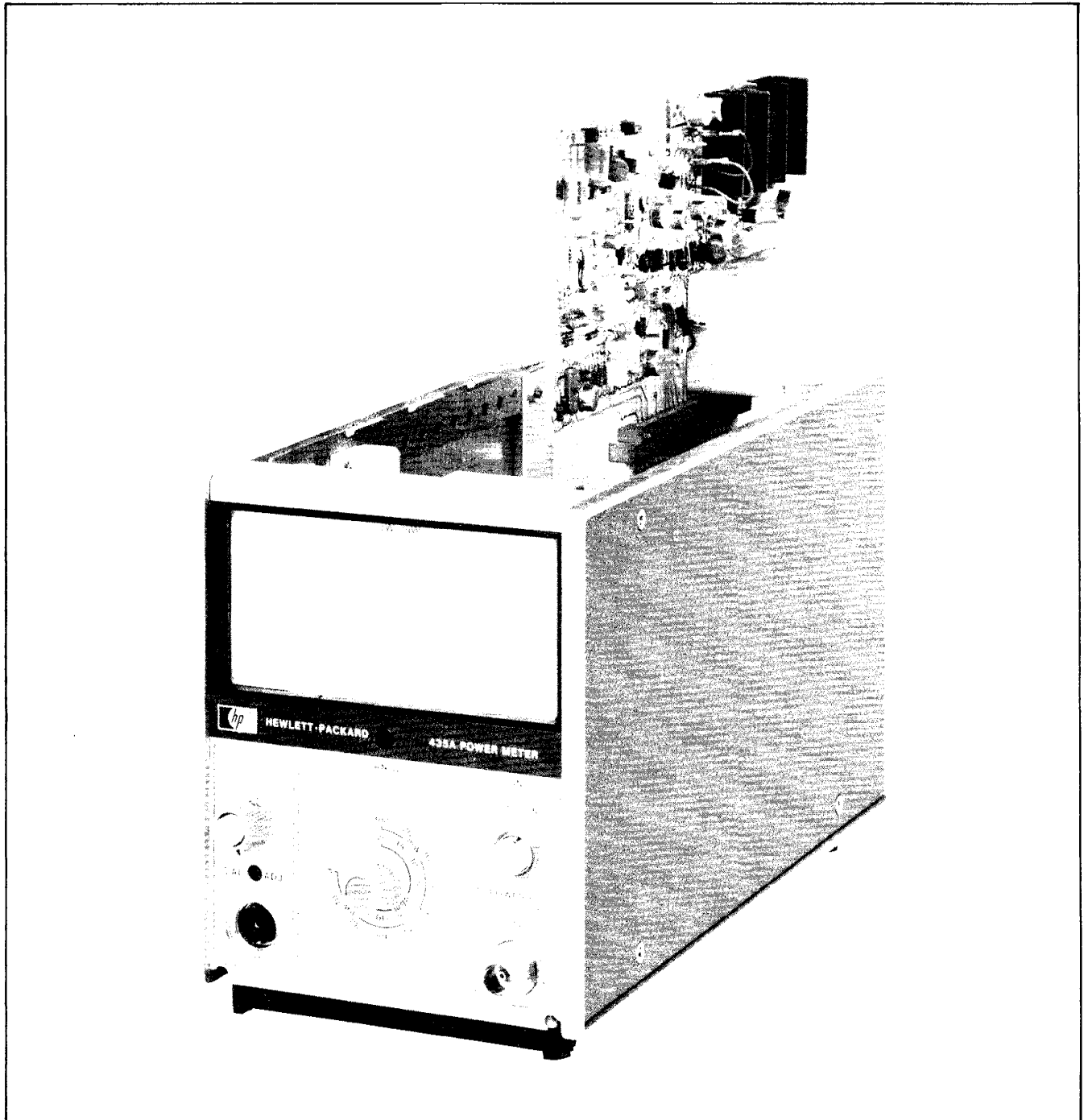

Figure 8-1. A4 Assembly Extended for Service

8-21. RECOMMENDED TEST EQUIPMENT

8-22. Equipment recommended in Table 1-3 should be used for testing and troubleshooting the 435A, to ensure that it is operating within the limits set forth in the specifications listed in Table 1-1. Test equipment that meets or exceeds the critical specifications listed may be used in place of the recommended equipment.

8-23. REPAIR

8-24. After repairing any circuitry within the 435A, refer to Section V and perform the adjustments.

8-25. Perform the tests in Section IV to ensure that the instrument is operating within the specified limits.

NOTE

If the A3 Power Reference Assembly is repaired, see the Power Reference Output test in Section IV for instructions on setting the power output level.

8-26. GENERAL SERVICE INFORMATION

8-27. Etched Circuit Boards

8-28. The etched circuit boards used in Hewlett-Packard equipment are the plated-through type consisting of metallic conductors bonded to both sides of an insulating material. The metallic conductors are extended through the component holes or interconnect holes by a plating process. Soldering can be performed on either side of the board with equally good results. Table 8-1 lists recommended tools and materials for use in repairing etched circuit boards. Following are recommendations and precautions pertinent to etched circuit repair work.

a. Avoid unnecessary component substitution; it can result in damage to the circuit board and/or adjacent components.

b. Do not use a high power soldering iron on etched circuit boards. Excessive heat may lift a conductor or damage the board or a component.

CAUTION

Do not use a sharp metal object such as an awl or twist drill to remove solder from component mounting holes. Sharp objects may damage the plated-through conductor.

c. Use a suction device or wooden toothpick to remove solder from component mounting holes.

d. After soldering, remove excess flux from the soldered areas and apply a protective coating to prevent contamination and corrosion.

8-29. Component Replacement

8-30. The following procedures are recommended when component replacement is necessary:

a. Remove defective component from board.

b. If component was unsoldered, remove solder from mounting holes with a suction device or a wooden toothpick.

c. Shape leads of replacement component to match mounting hole spacing.

NOTE

Although not recommended when both sides of the circuit board are accessible, axial lead components such as resistors and tubular capacitors, can be replaced without unsoldering. Clip leads near body of defective component, remove component and straighten leads left in board. Wrap leads of replacement component one turn around original leads. Solder wrapped connection and clip off excess lead.

d. Insert component leads into mounting holes and position component as original was positioned. Do not force leads into mounting holes; sharp lead ends may damage the plated-through conductor.

8-31. Operational Amplifiers

8-32. **Operational Amplifiers Function.** Operational amplifiers are used to provide such functions as summing and offsetting voltages, as buffer amplifiers, detectors, and in power supplies. The particular function is determined by the external circuit connections. Equivalent circuit and functional diagrams for typical operational amplifiers are contained in Figure 8-2. Circuit A is a non-inverting buffer amplifier with gain of one. Circuit B is a non-inverting amplifier with gain determined by the resistance of R1 and R2. Circuit C is an inverting amplifier with gain determined by R1 and R2, with the input impedance equal to R2. Circuit D contains the functional

circuitry and pin connection information with an operational amplifier review. Circuit D contains the functional circuitry and pin connection information with an operational amplifier review.

NOTE

It is assumed that the amplifier has high gain, low output impedance and high input impedance.

8-33. Troubleshooting. An operational amplifier can be characterized as an ideal voltage amplifier having low output impedance, high input impedance, and very high gain. Also the output voltage is proportional to the difference in the voltages *applied* to the input terminals. In use, the

amplifier drives the input voltage difference close to zero.

8-34. When troubleshooting an operational amplifier, measure the voltages at the two inputs with no signal applied; the difference between these voltages should be less than 10 mV. A difference voltage much greater than 10 mV indicates trouble in the amplifier or its external circuitry. Usually this difference will be several volts and one of the inputs will be very close to an applied circuit operating voltage (for example, +20V, -12V).

8-35. Measure the amplifier's output voltage. It will probably be close to one of the supply voltages

Table 8-1. Etched Circuit Soldering Equipment

Item	Use	Specification	Item Recommended
Soldering tool	Soldering Unsoldering	Wattage rating: 47½ – 56½ Tip Temp: 850 – 900 degrees	Ungar No. 776 handle with *Ungar No. 4037 Heating Unit
Soldering* tip	Soldering Unsoldering	*Shape: pointed	*Ungar No. PL111
De-soldering Aid	To remove molten solder from connection	Suction device	Soldapult by Edsyn Co. Arleta, California
Resin (flux)	Remove excess flux from soldered area before application of protective coating.	Must not dissolve etched circuit base board material or conductor bonding agent.	Freon, Aceton, Lacquer Thinner, Isopropyl Alcohol (100% dry)
Solder	Component replacement Circuit board repair Wiring	Resin (flux) core, high tin content (60/40 tin/lead), 18 gauge (SWG) preferred	
Protective coating	Contamination, corrosion protection	Good electrical insulation, corrosion-prevention properties	Silicone Resin such as GE DRI-FILM**88
<p>* For working on etched boards; for general purpose work, use Ungar No. 1237 Heating Unit (37.5W, tip temperature of 750–800 degrees) and Ungar No. PL113, 1/8-inch chisel tip.</p> <p>**General Electric Co., Silicone Products Dept., Waterford, New York, U.S.A.</p>			

or ground. Verify that the output voltage follows the input voltages, i.e., if the non-inverting input voltage is more positive than normal and/or if the inverting input voltage is more negative than normal, then the change in output voltage should be more positive. If the non-inverting input is less

positive and/or the inverting input voltage is less negative, the change in output voltage should be less positive. The preceding symptoms indicate the defective component is in the external circuitry. If the symptoms as stated are absent, the operational amplifier is probably defective.

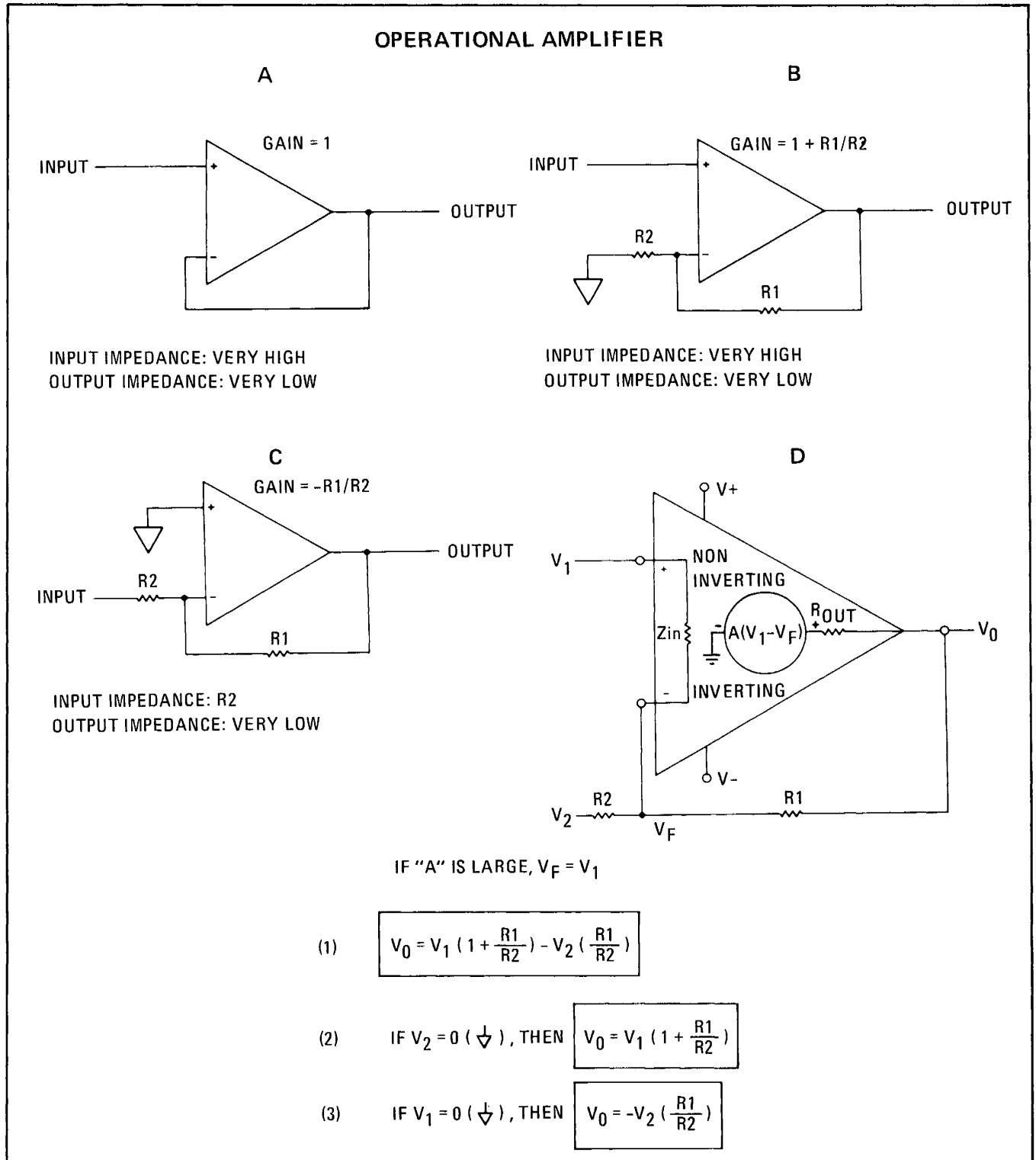



Figure 8-2. Operational Amplifier Equivalent Circuit

SCHEMATIC DIAGRAM NOTES

Resistance in ohms, capacitance in microfarads, inductance in millihenries unless otherwise noted.
microhenries

***** Asterisk denotes a factory-selected value. Value shown is typical. Part may be omitted.

 Tool-aided adjustment.

 Manual control.

 Encloses front-panel designation.

 Encloses rear-panel designation.

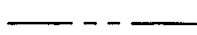
 Circuit assembly borderline.

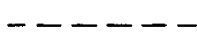
 Other assembly borderline. Also used to indicate mechanical interconnection (ganging).



 Heavy line with arrows indicates path and direction of main signal.

 Heavy dashed line with arrows indicates path and direction of main feedback.

 Wiper moves toward CW with clockwise rotation of control (as viewed from shaft or knob).

 Numbered Test point. Measurement aid provided.

 Lettered Test point. No measurement aid provided.

 Encloses wire color code. Code used is the same as the resistor color code. First number identifies the base color, second number identifies the wider stripe, third number identifies the narrower stripe. E.g.,  denotes white base, yellow wide stripe, violet narrow stripe.

 A direct conducting connection to the earth, or a conducting connection to a structure that has a similar function (e.g., the frame of an air, sea, or land vehicle).

 A conducting connection to a chassis or frame.

 Common connections. All like-designated points are connected.

 Letter = off-page connection.
Number = Service Sheet number for off-page connection.

Figure 8-3. Schematic Diagram Notes (1 of 3)

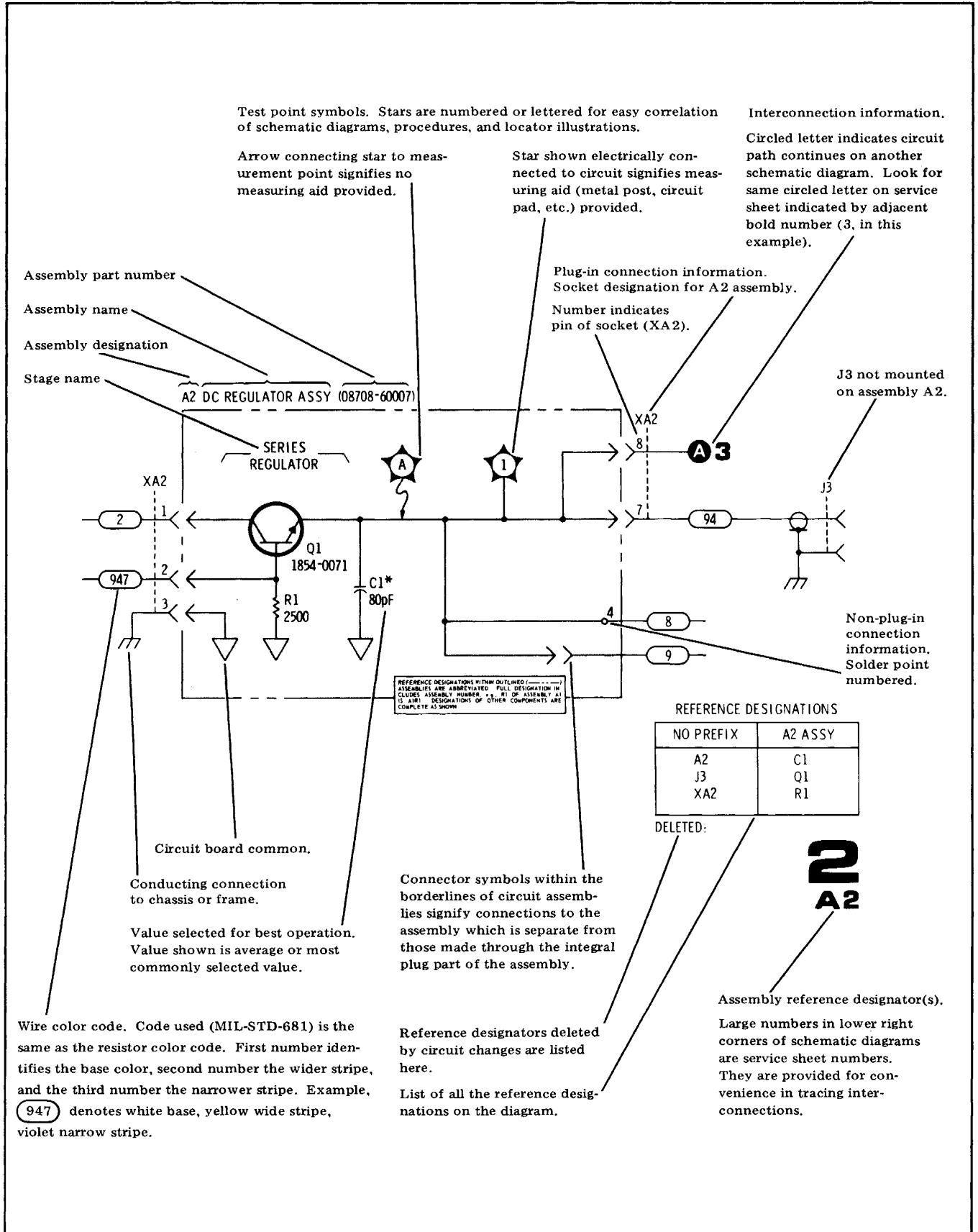

Figure 8-3. Schematic Diagram Notes (2 of 3)

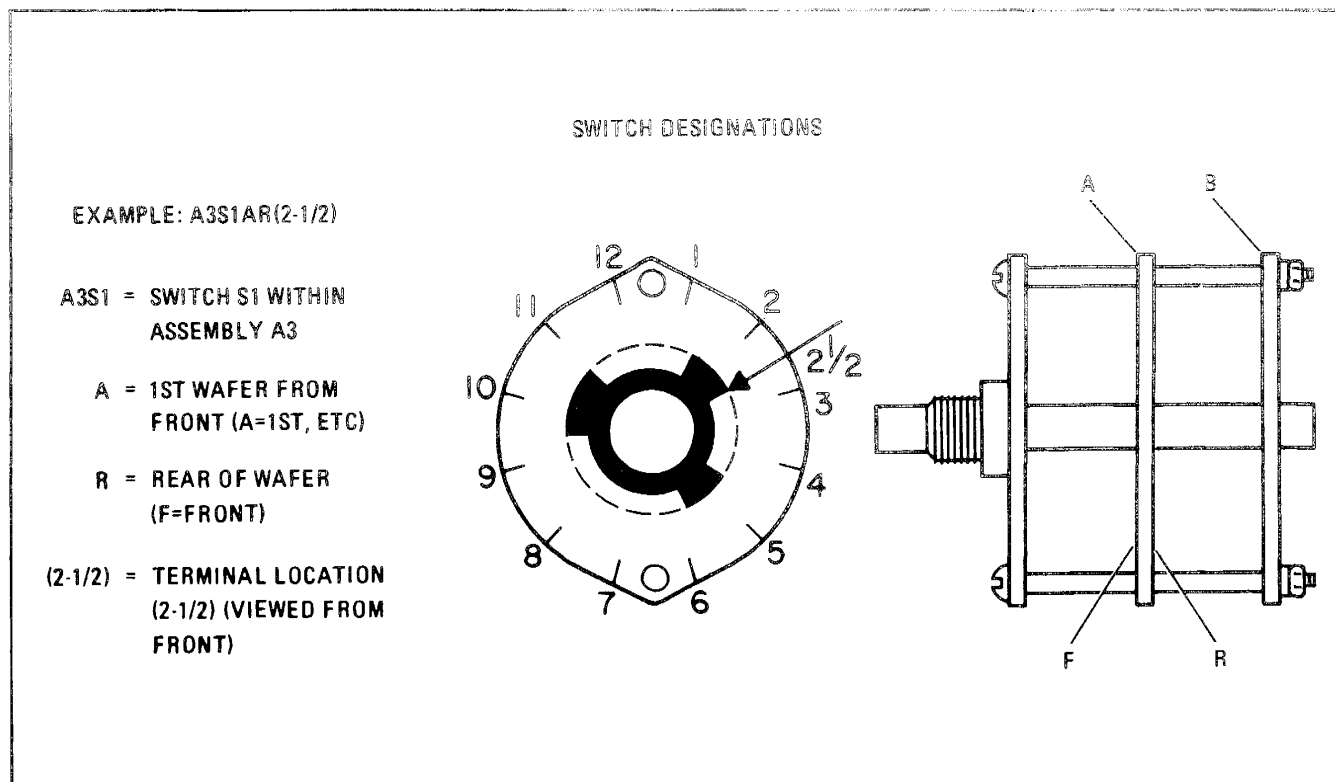

Figure 8-3. Schematic Diagram Notes (3 of 3)

SERVICE SHEET I

PRINCIPLES OF OPERATION

General

The Power Meter and a compatible Power Sensor are used to measure RF power levels. For example, the power range of the HP Model 8481A is from -35 to $+20$ dBm ($\approx 0.3 \mu\text{W}$ to 100 mW) into 50Ω ; the frequency range is from 10 MHz to 18 GHz .

Power Sensor

The power sensing device dissipates the input RF energy into 50 ohms and produces a dc voltage proportional to the power level. This dc voltage is sampled creating an ac signal which is coupled to the Input Amplifier for amplification.

AC Amplifiers/A2 Range Switch Assembly

The ac signal is amplified by the Power Sensor's Input Amplifier and the Power Meter's First, Second, and Third Amplifiers. The RANGE switch attenuators which are placed between the First and Second and Second and Third amplifiers are used to set the range-to-range gain of the Power Meter amplifiers.

DC Circuits

The Synchronous Detector converts the ac signal back to dc. The output is coupled to the DC Amplifier via a Low Pass Filter network which is part of the A2 Range Switch Assembly. The DC Amplifier drives the meters, the Servo Amplifier, and possibly an external device through the RECORDER OUTPUT jack.

Servo Amplifier/Auto Zero

The Servo Amplifier output. When the zero switch is pressed, the Servo Amplifier output is connected to the auto zero circuit, which zeroes the feedback loop voltage (error signal) to the auto zero circuit. The auto zero circuit is a temperature output sensing device. The auto zero circuit is the feedback loop output to ground. When the zero switch is pressed, the auto zero circuit holds the error

Power Reference As

The A3 Power Reference As provides a 10 MHz oscillator with a 100 mV peak-to-peak output providing an except calibrated output is

Power Supply

The Power Supply is a shunt regulator circuit. The shunt regulator plate is connected between the 24V supply output and the battery charging and is operative with the battery

TROUBLESHOOTING

General

Before beginning to troubleshoot, remove the cover from the instrument and measure the dc voltage at TP9 and TP10.

When a malfunction is found, refer to the Troubleshooting Sheet for component

Block Diagram Trou

The waveforms and voltages shown on the schematic when operating under the following conditions.

SERVICE SHEET 2 (cont'd)

of the waveform varies slightly, the performance of the system will not be degraded. Measuring and recording dc voltages and comparing them with the normal levels shown on the schematic may help to isolate defective components. Refer to General Service Information (in Section VIII) with regard to operational amplifier circuits.

The waveforms and voltages shown on the schematic are normal when operating under the following conditions.

NOTE

To exhibit the correct waveforms in the RANGE switch positions indicated, the Power Sensor (as part of the measurement system) must measure power from -35 to +20 dBm into a 50Ω load.

a. **POWER METER AND SENSOR.** Set the Power Meter RANGE switch to the 1 mW position, CAL FACTOR switch to 100%, and the rear panel POWER REF switch to (ON). Connect the Power Sensor to the Power Meter's POWER REF OUTPUT jack.

b. **POWER METER AND HP MODEL 11683A RANGE CALIBRATOR.** Set the Power Meter's RANGE switch to the 1 mW position and CAL FACTOR switch to 100%. Set the Range Calibrator's RANGE switch to 1 mW, POLARITY switch to NORMAL, and FUNCTION switch to STANDBY. Connect the Range Calibrator to the Power Meter with the Power Sensor Cable. Set the Range Calibrator FUNCTION switch to CALIBRATE.

First Amplifier

To troubleshoot the hybrid operational amplifier effectively, consider the complete amplifier as shown on the schematic on the opposite foldout and the Power Sensor's schematic.

The bias levels may be used most effectively to isolate the problem to the Power Meter. If the dc voltage at TP1 is correct but the dc voltage is incorrect, a defective component probably exists in the Power Sensor before the signal is input to the hybrid amplifier.

A dc voltage coupled with a positive voltage ($\cong +3$ Vdc) at A4U pin 2 would indicate a defect in the Power Sensor's hybrid amplifier input or the interconnect cable. If the voltage at pin 2 is about 0.0 Vdc, the defective component is probably in the Power Meter's First Amplifier.

A positive voltage at TP1 indicates the malfunction is probably in the Power Meter's First Amplifier.

SERVICE SHEET 2 (cont'd)**NOTE**

Do not overlook the possibility that a problem can exist in the Auto-zero circuits shown on Service Sheet 3.

An increased noise level may be caused by C1, C6, or C30 line noise filters.

Range-to-range inaccuracy between the 100 mW range and another range may be due to a shaping circuit defect.

A2 Range Switch Assembly

Range-to-range inaccuracy which is caused by the RANGE switch attenuators can easily be isolated by performing one of the Instrumentation Accuracy Performance Tests (refer to Section IV).

Third Amplifier

Adjust the CAL ADJ control from its present setting to the ccw stop. Then adjust the control the cw stop. The meter reading will normally change by ± 2 dB (> 4 dB from stop to stop). The ac voltage at TP4 will change from the nominal setting to approximately -35% (ccw stop) and $+70\%$ (cw stop).

Synchronous Detector

The phase change of the 220 Hz signal between the Power Sensor's sampling gate and the Synchronous Detector cannot be measured directly because the detector output is dc rather than ac. However, the phase difference at TP4 (the input to the detector circuit) can be measured. Because the phase change between TP4 and the detector is known, the phase relationship between the drive signal (TP7) and the TP4 signal indicates the total phase shift through the ac amplifiers. This is the step-by-step procedure for checking phase shift.

a. Set the Power Meter and (if used) the Range Calibrator controls as shown in the general troubleshooting information above.

b. Connect the oscilloscope's vertical inputs to the 220 Hz drive (TP7) through a divide-by-ten probe (Channel A) and to TP4 through a one-to-one probe (Channel B).

c. Set the oscilloscope controls as follows: Channel A sensitivity to 0.05V/division with ac coupling, Channel B sensitivity to 0.2V/division, horizontal sweep to 0.5 ms/division, and the

display mode to Channel A and B, chopped with triggering from B.

d. Adjust the vertical position controls until both traces are symmetrical with respect to the horizontal center line (refer to the typical waveform below).

e. Set the time base magnifier control to X10. The horizontal scale is now 50μ /division (refer to the expanded waveform below).

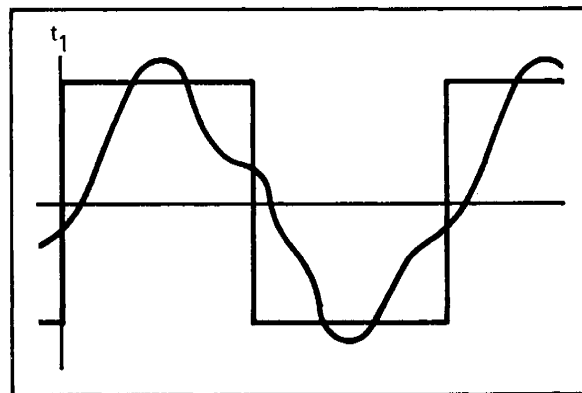

TYPICAL WAVEFORM

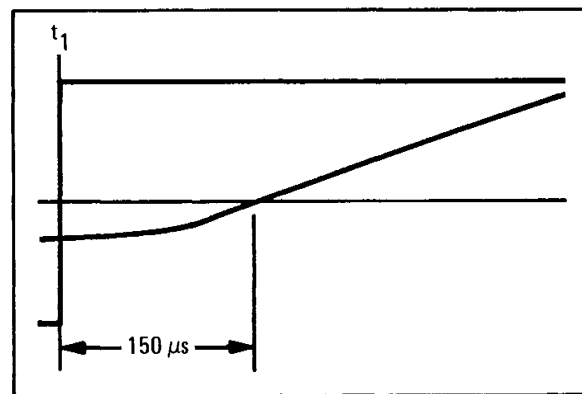

EXPANDED WAVEFORM

f. Set the Power Meter's rear panel POWER REF switch to OFF or set the Range Calibrator's FUNCTION switch to STANDBY. With the Oscilloscope's Channel A position control, set the trace representing a zero input at TP4 to the grid horizontal center line.

g. Set the Power Meter's POWER REF switch to (ON) or set the Range Calibrator's FUNCTION switch to CALIBRATE. The zero crossing of the Channel A (TP4) trace should lag the drive signal by $150 \pm 75 \mu$ s.

A2 ASSY
(View From Instrument Right Side)

R2
R1 IS CONNECTED IN
POSITION INDICATED
BUT ON OPPOSITE
SIDE OF SWITCH

S1

R3

R4

R5

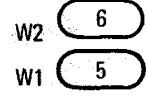

Figure 8-5. P/O A2 Range Switch Assembly (Attenuator) Component Locations

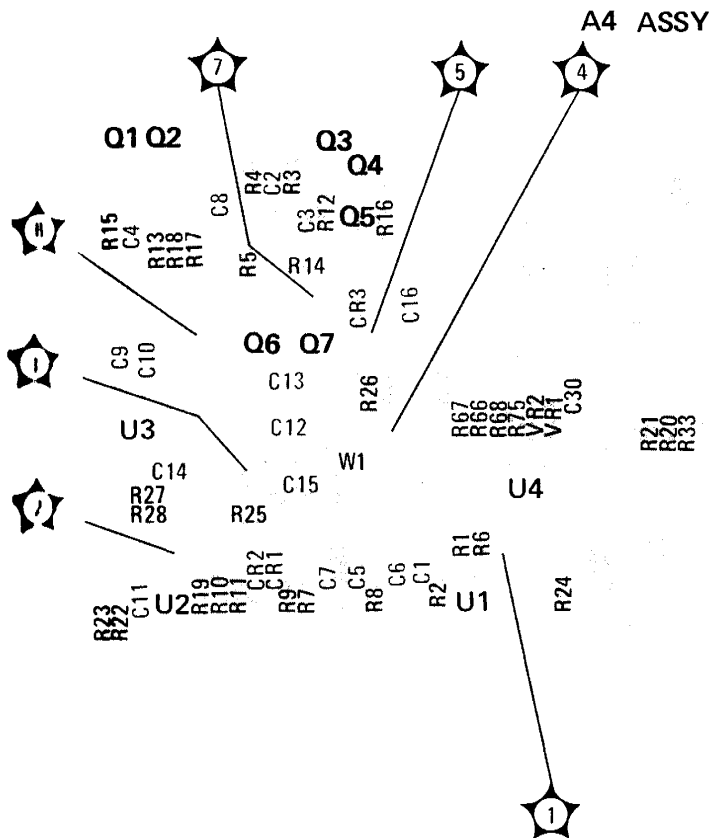

Figure 8-6. P/O A4 Assembly (DC Ampl/Sync Detector) Component and Test Point Locations

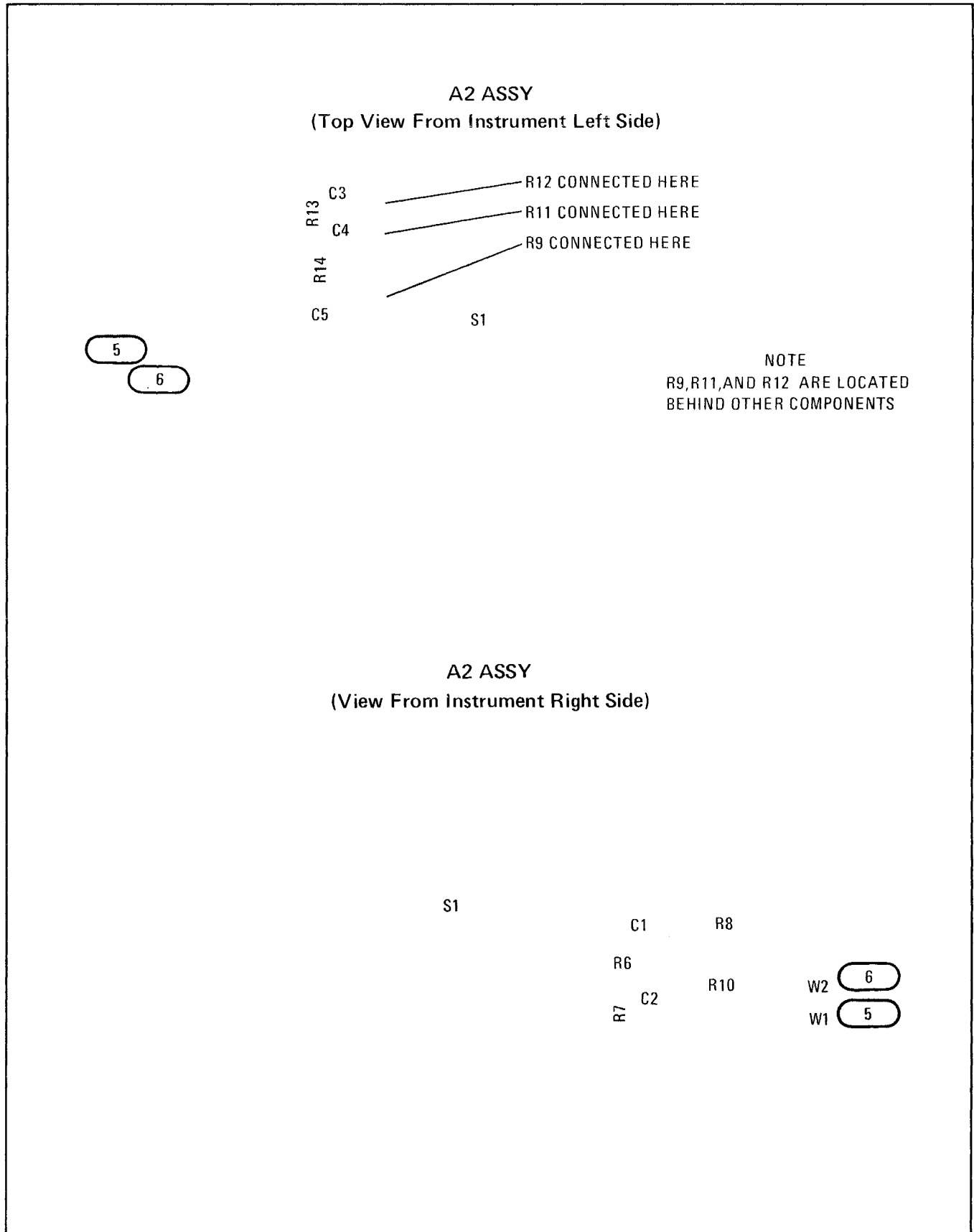

Figure 8-8. A2 RANGE Switch Assembly (Low Pass Filters) Component Locations

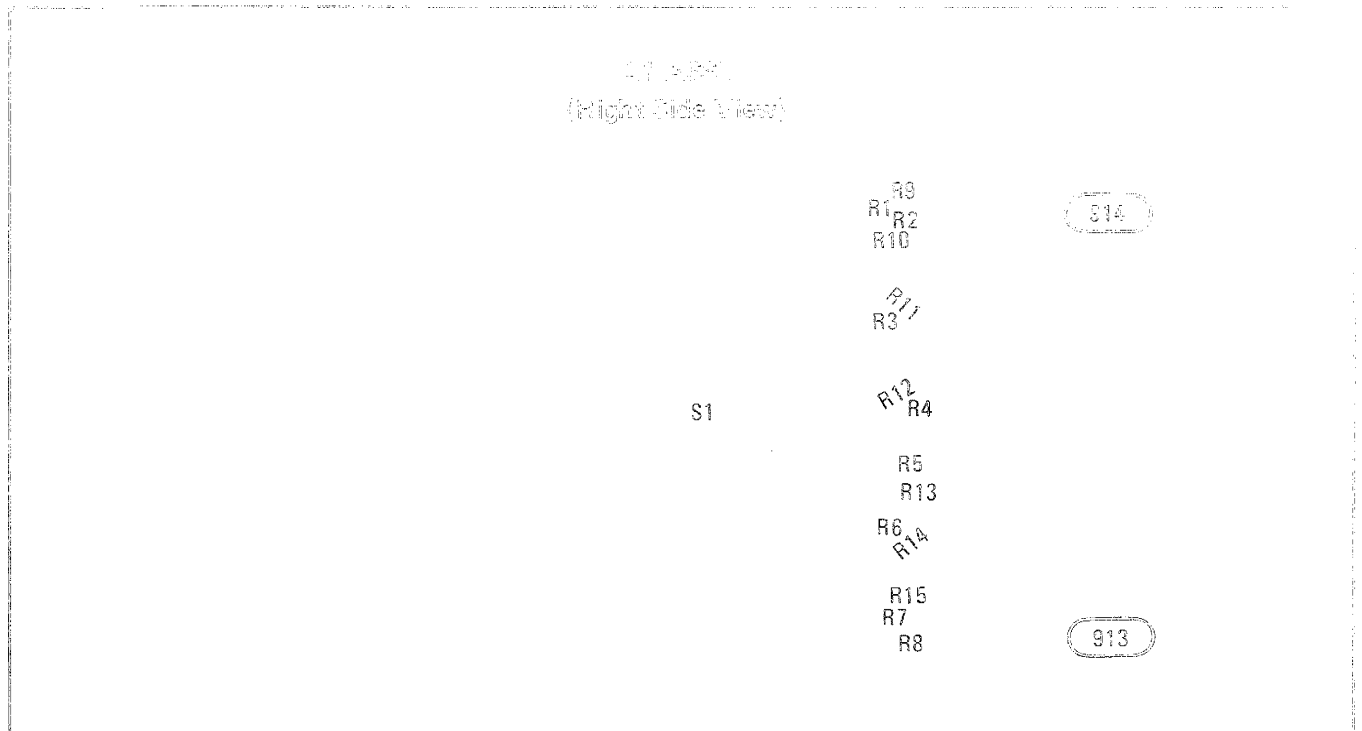

Figure 8-9. A1 Cal Factor Switch Assembly Component Locations

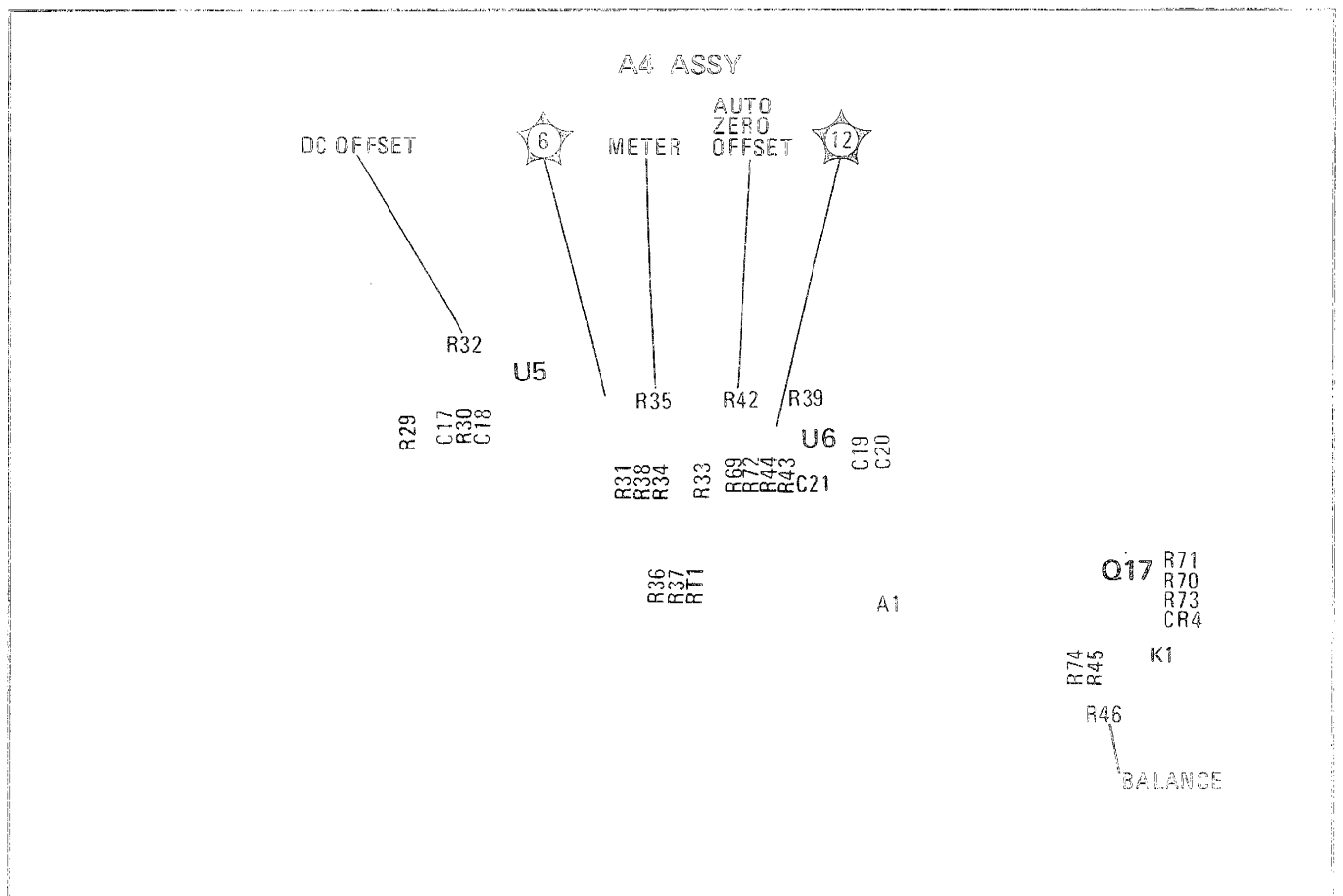

Figure 8-10. P/C A4 Assembly (DC Amp/Auto Zero) Components and Test Point Locations

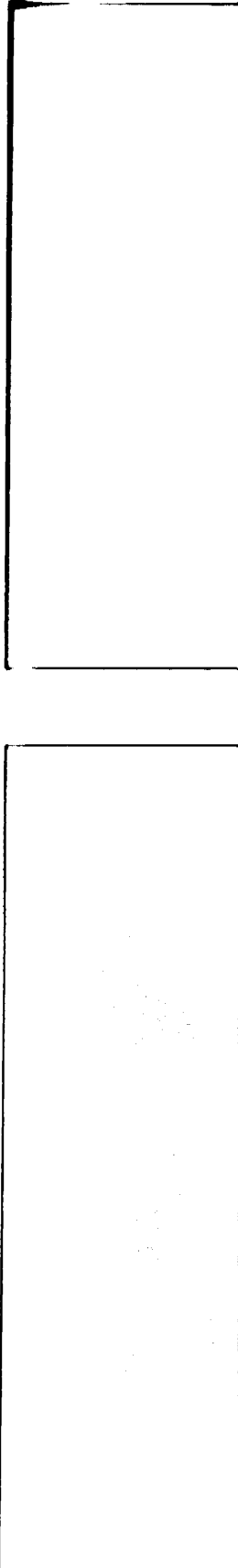

Figure 8-10.

SERVICE SHEET 4

PRINCIPLES OF OPERATION

General

The A3 assembly provides a 50 ± 5 MHz output at $1 \text{ mW} \pm 0.7$. The oscillator output is held constant by an ALC loop made up of a peak detector CR2 and comparator U2. The comparator reference input is from a very stable +5V power supply composed of U1, VR1, and their associated components. The LEVEL control R3 sets the comparator reference which controls the oscillator feedback level and thereby controls the A3 assembly POWER REFERENCE OUTPUT level.

50 MHz Oscillator

The oscillator circuit is made up of common emitter amplifier and its associated components. Resistors R10, R11, R12 and bias Q1 for an emitter current of approximately 5 mA. The π -network tuned circuit, C9, L2, C10, and C11 determines operating frequency. The amplifier ac gain is set by the operating circuit impedance across the tuned circuit and the emitter resistor R12 (which is ac coupled to ground by C12). The positive feedback required to sustain oscillation is satisfied in this circuit. Phase shift of 180° is a characteristic of both common-emitter transistor amplifiers and π -network tuned circuits. This feedback is coupled through C7 and C8, back to the base of Q1.

ALC Loop

At the positive peak of each cycle, current momentarily flows from the feedback loop through peak detector diode CR2 to the output. The resultant stored charge is coupled, as a dc input voltage, to pin 3 of U2. The detector output is compared to a very stable reference input by comparator U2. Any difference between the comparator's input voltages produces an error voltage at the output. The comparator output is coupled to a reactance voltage divider, capacitor C7 and varactor CR3. As the error output voltage goes more positive the capacitive reactance of C7 decreases, which reduces the oscillator feedback. Conversely, more negative output voltage will increase the feedback. For example, if the oscillator output were to suddenly increase, the detector output would become more positive. The comparator output would become more positive, a lower CR3 reactance would decrease the feedback to Q1 which forces the oscillator output level back to its original level. If the R3 LEVEL control were adjusted for a more positive reference voltage, the comparator output would go more negative, the feedback would increase allowing the oscillator output to increase. Therefore, the peak detector output would increase until it equals the comparator reference level input, thus establishing a higher leveled-out signal from the oscillator.

A1 CAL FACTOR Switch Assembly
 P/O A2 RANGE Switch (Low Pass Filters) Assembly
 P/O A4 Assembly (DC Amp/Auto Zero)

◀ SERVICE SHEET 3

SERVICE SHEET 4 (cont'd)

Frequency shaping components R7, R8, R9, and C6 determine the upper limit of frequency response of the ALC loop which prevents spurious oscillations.

+5V Power Supply

A3VR1 provides a reference voltage of -6.2 Vdc to the power supply reference amplifier A3U1. The gain of the reference amplifier is set by R2, R3, and R4 and is approximately -0.8 with R3 centered. The very stable output is coupled through CR1 as the reference voltage input to comparator U2. Diode CR1 temperature compensates CR2.

TROUBLESHOOTING

General

Before trying to troubleshoot the A3 assembly, verify the presence of $+12$ Vdc and -12 Vdc on the circuit board.

If a defect in the A3 assembly is isolated and repaired, the correct output level (1 mW \pm 0.7%) must be set by a very accurate power measurement system. Hewlett-Packard employs a special system, accurate to $\pm 0.5\%$ and traceable to the National

Bureau of Standards. When setting the power level, a transfer error of $\pm 0.2\%$ is introduced making the total error $\pm 0.7\%$. If a system this accurate is available it may be used to set the proper output level. Otherwise, Hewlett-Packard recommends returning the Power Meter so it can be reset at the factory. Contact your nearest Hewlett-Packard office for more information.

50 MHz Oscillator

Malfunions of the oscillator circuits will occur as a wrong output frequency or as an abnormal output level. The voltage at TP2 will indicate if the ALC loop is trying to compensate for an incorrect output level.

Modulation of the 50 MHz signal or spurious signals, which are part of the output, may be caused by defects in R7, R8, R9, or C6 in the ALC loop.

ALC Loop and Power Supply

Isolating problems in the ALC Loop and Power Supply circuits may be quickly isolated by measuring dc voltages at the inputs and outputs of the integrated circuits. For added information on troubleshooting integrated circuits, refer to General Service Information in Section VIII.

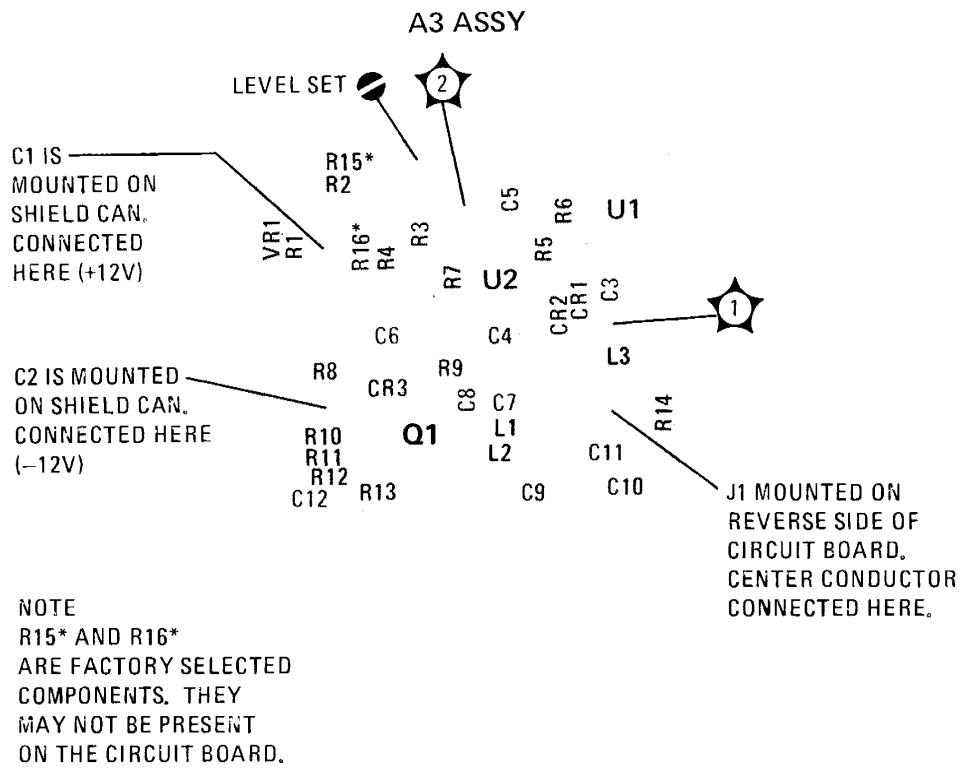

Figure 8-12. A3 Power Reference Assembly Component and Test Point Locations

SERVICE SHEET 5

PRINCIPLES OF OPERATION

General

Power Sources for the Power Meter are line (Mains) power or the rechargeable battery. If the battery is being used as a power source, it will receive a charging current anytime the line voltage is coupled to the instrument and the LINE switch is set to ON. When the line voltage is disconnected, the battery automatically becomes the power source.

CAUTION

A voltmeter or oscilloscope which is used to measure the 24V output across the +12V terminals must have a floating ground input.

The 12V Shunt Regulator establishes a reference ground at the half voltage point of the 24V Series Regulator output and thus establishes the +12 and -12 Vdc outputs with respect to ground.

24V Series Regulator

NOTE

The explanation of the 24V Series Regulator is based on the assumption that TP9 is the reference ground and the regulator output is -24 Vdc at TP10.

A reference voltage of -12 Vdc is established on the base of Q11 by VR4. Because Q10 and Q11 are a differential amplifier pair a difference in voltage between the base of Q11 and the base of Q10, half the 24V output (refer to the note above), produces an error output on the collector of Q11. This error voltage is coupled to Q16, the regulator driver, and from there to Q13, the series regulator. If, for example, the output voltage suddenly decreased to -23 volts, the current through Q11 would increase and the collector voltage would become less negative. Current flow through Q16 increases and the collector voltage goes more negative. The emitter voltage of Q13 follows the collector voltage of Q16 and approaches -24V. As the output voltage becomes more negative, the Q10 base voltage also becomes more negative until it equals the base voltage of Q11. At this instant, the output voltage is -24 Vdc and the circuit action (voltage change) ceases.

Regulating action of the 24V supply is started by CR9, R58, and R60. When the LINE switch is set to ON, current begins to flow through R60 and VR4. As the voltage increases across VR4, current begins to flow through Q11 which biases Q13 and Q16 on. The regulator output begins to increase in a negative direction. The output voltage biases CR9 which, in turn, causes the voltage across VR4 to increase. The resulting rapid increase in voltage on the base of Q11 keeps it ahead of that on the base of Q10. When the Q11 base voltage stabilizes at -12Vdc, the lower voltage on Q10 keeps the output level increasing until it approaches -24Vdc. At this point the base voltages of Q10 and Q11 become equal, the differential amplifiers error output goes to zero, and the output is stabilized at -24V.

Fig.

SERVICE SHEET 5 (cont'd)

C25 and R61 form a low pass filter which reduces the high gain of the circuit at high frequencies thus preventing unwanted oscillations. R59 and C24 form a noise filter for the zener diode.

The input voltage to the 24V regulator may be as high as 70 Vdc from the line voltage or as low as 26 Vdc from the battery.

12V Shunt Regulator

U7 is connected as a voltage follower circuit through the base-emitter junctions of Q8 and Q9. Chassis ground is coupled to the inverting input of U7 and the non-inverting input is coupled across half the 24V series regulator output by a voltage divider R63 and 64. If the voltage input to pin 3 tries to shift toward +12 or -12 Vdc, the output from U7 would cause either Q9 or Q8 respectively to conduct and bring the voltage at U7 pin 3 back to ground potential. For example, if the voltage at pin 3 goes positive, the output follows the input and goes positive which biases Q9 on and the current flow through Q9 brings U7 pin 3 back to ground potential.

Battery Test**NOTE**

The battery test circuit is in operation any time the LINE switch is set to ON, however the only time the meter indication is meaningful is when the battery is supplying power.

When the battery is supplying power for the Power Meter circuits, and the battery is defective or discharged, the battery test circuit removes the positive (+12Vdc) supply voltage from the DC Amplifier (A4U5). This causes a full downscale meter indication.

The test circuit measures a percentage of the voltage difference between the -12V output and the negative battery terminal. As this voltage difference decreases to approximately 3 Vdc, Q14 begins to turn off. The collector voltage begins to go positive and the change is transmitted through R51 and CR8 to Q18. As Q18 begins to turn off, its collector goes more negative. A negative going

transient is coupled through R55 to the base of Q14 which speeds up the turn-off time. The positive supply voltage is removed from the collector of Q18 and also the DC Amplifier. As the battery voltage is further reduced, the series regulated output begins to decrease faster than the battery voltage and, eventually, the 3 volt threshold voltage is exceeded. Q14 is then biased on, but because the battery voltage is less than 20 Vdc, the knee voltage of CR8 cannot be reached. Therefore, CR8 does not conduct and Q18 remains biased off.

Battery Charger

If a battery has been placed in the Power Meter as a secondary power source, it is always being charged whenever the line voltage is coupled to the instrument and the LINE switch is ON. With ac line (Mains) power supplying energy, VR3 is turned on which biases Q12 for a charging current of approximately 90 mA. This current is supplied through CR6 to the battery BT1. CR7 is reversed biased while the battery is being charged. When the line voltage is removed, CR7 is forward biased by the current flowing to the Power Meter circuits from the battery. CR6 is turned off and no current flows through the charging circuit.

Current Limiter

If the current flow through the 24V regulator were to suddenly increase to approximately 90 mA, Q15 would turn on and draw the drive current away from Q16. Consequently, the current flow to Q13 would disappear and the regulator output would be reduced.

TROUBLESHOOTING

Set the line switch to off and remove A4P1 (red wire) from A4J1 and A4P2 (blue wire) from A4J2. This disconnects the load from the power supply. If the supply voltages are now correct, the malfunction is not in the power supply.

If, after removing the load, the output voltages measured are less than normal but of equal and opposite polarity, the malfunction is probably in the series regulator circuits.

Voltages shown in parenthesis are for battery operation only.

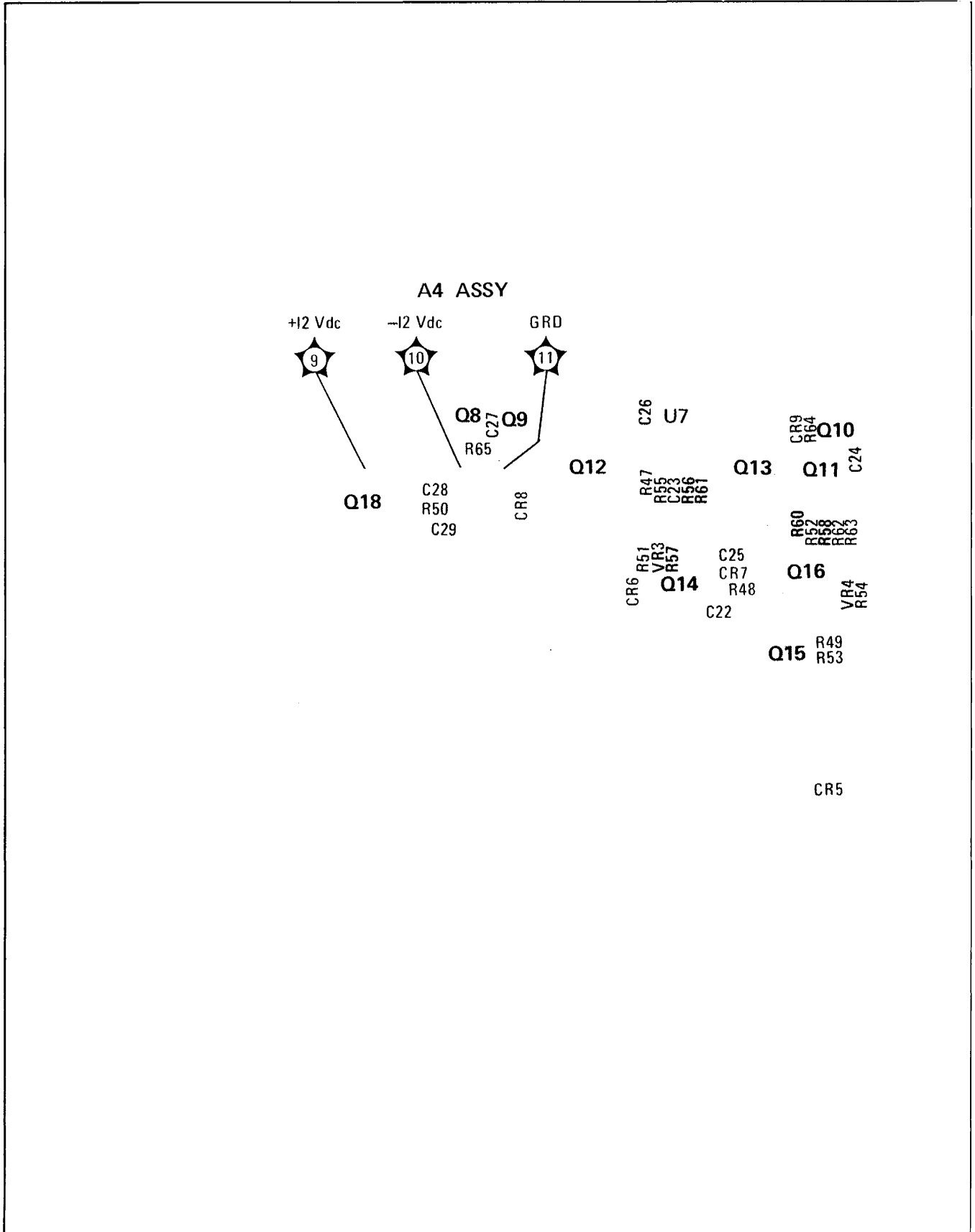

Figure 8-14. P/O A4 Assembly (Power Supply) Component and Test Point Locations

Table 8-2. Assembly and Chassis and Adjustable Component Locations

Assembly or Component Reference Designator	Service Sheet	Figure	Remarks
A1 Assembly	3	8-9	
A2 Assembly	2, 3	8-5, 8, 16	
A2W1	2	8-5, 8, 16	8-16 Front Panel Int. View
A2W2	2	8-5, 8, 16	8-16 Front Panel Int. View
A3 Assembly	4	8-12, 16	
A3R3 LEVEL SET CONTROL	4	8-12, 16	8-16 Top View
A4 Assembly	2, 3, 5	8-6, 10, 14, 16	
A4R32 DC OFFSET CONTROL			
A4R35 METER CONTROL	3	8-10, 16	8-16 Right Side View
A4R12 AUTO ZERO OFFSET CONTROL	3	8-10, 16	8-16 Right Side View
A4R16 BALANCE CONTROL	3	8-10, 16	8-16 Right Side View
A4A1 Assembly	3	8-10, 16	
A5 Assembly	5	8-16	
J1	2	8-16	
J2	4	8-16	
J3	3	8-16	8-16 Rear Panel Int. View
J4	3	8-16	8-16 Rear Panel Int. View
J5	2	— —	Rear Panel Connector
M1	3	8-16	
P19	5	— —	Cable coupling from S1 & T1 to A5 Assembly
P10	4	8-16	8-16 Front Panel Int. View
R1 CAL FACTOR CONTROL	2	8-16	
R2	5	— —	Connected to S1 inside safety cover
R1	5	8-16	
R2	3	8-16	
R3	4	8-16	8-16 Rear Panel Int. View
T1	5	8-16	8-16 Rear Panel Int. View
W1	2	8-16	
W2	5	8-16	
W3	4	8-16	
W4	2	— —	Power Sensor Cable
W5	5	— —	Power Cable
W6	2	— —	Rear Panel INPUT CONNECTOR (Opt. 002, 003 only)
W7	2	— —	Coupled to R1 and XA4 pin 8
W8	2	— —	Coupled to R1 and XA4 pins 27 and 28
W9	4	— —	Takes place of W3 (Opt. 003 only)
XA1	2, 3, 5	8-16	

HEWLETT *hp* PACKARD